

IN
T
E
R
I
O
R
D
E
S
I
G
N

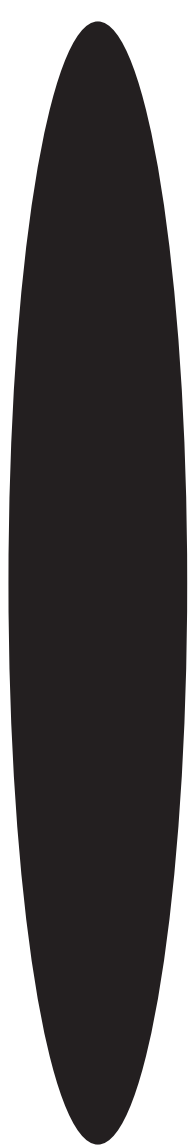

2021
2021
2021
2021

MY PORTFOLIO

KASUGA MOEKA

カスガ モエカ

イ
ン
テ
リ
ア

デ
ザ
イ
ン

DESIGNER



TOKYO
2002.02.21

mycolors: green and brown

like:take pictures

CONTENTS

3 – 10

CAFETERIA AND 2000_DESIGN BOOKS

11 water

13 name cade

14 hotel renovation

16 perth

15 color scheme

17 vector works

19 shutter street

18 residential hotel

20 apartment design



CAFETERIA AND 2000_DESIGN BOOKS

INTERIOR DESIGN

3

CAFETERIA AND 2000_DESIGN BOOKS

広場の

gakusei ho-ru

second floor



OKS...
DESIGN

どこに座ろうか、

どこでのんびりしようか、

どこで会話しようか、

どこで読書しようか

日常にさりげない選択を

カフェテラスのような自然光を感じられ
くつろげる空間を

Id-B 8 KASUGA MOEKA

ような皆の空間
テラスのような皆の空間

ground plan

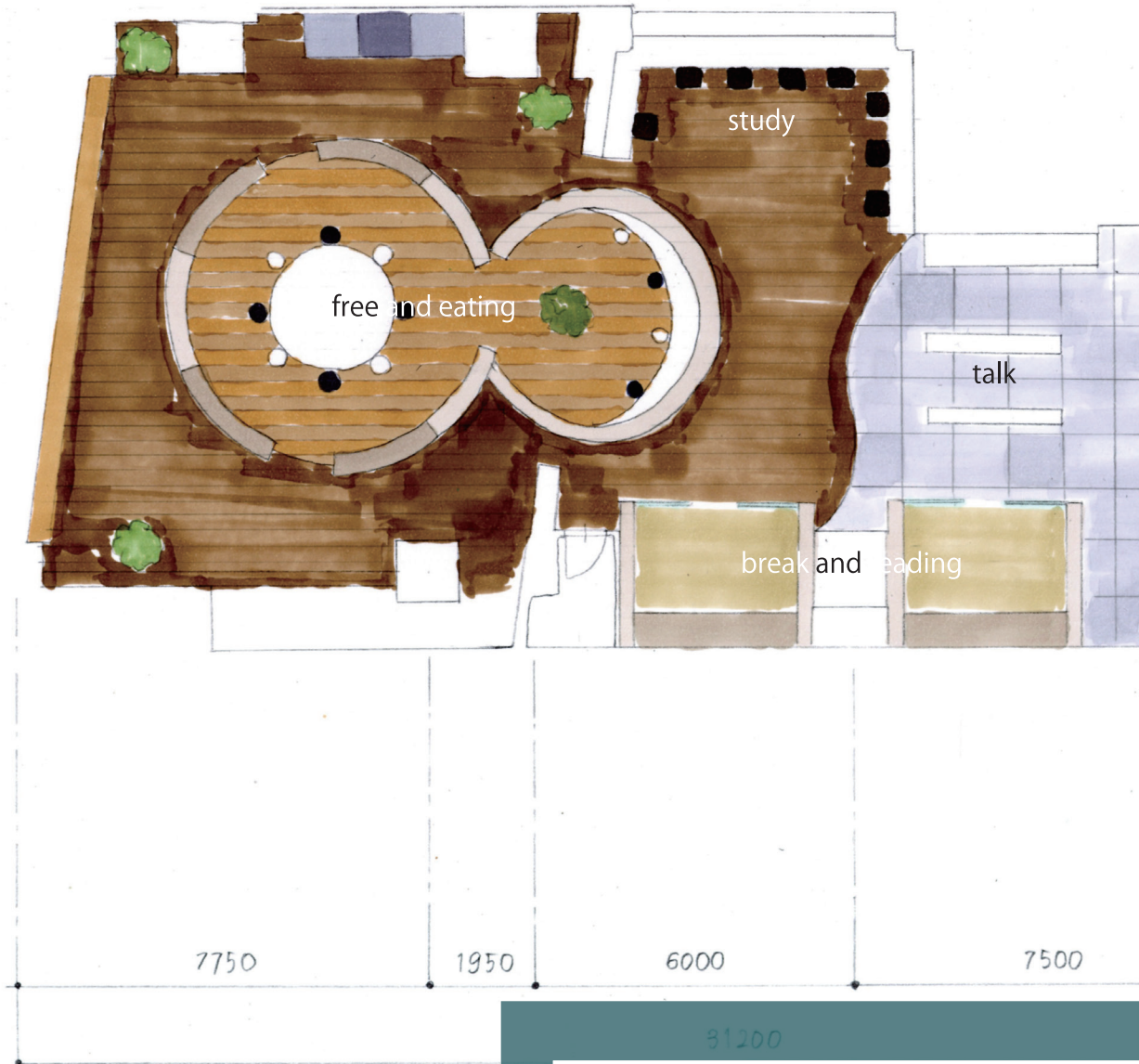

5

CAFETERIA AND 2000_DESIGN BOOKS

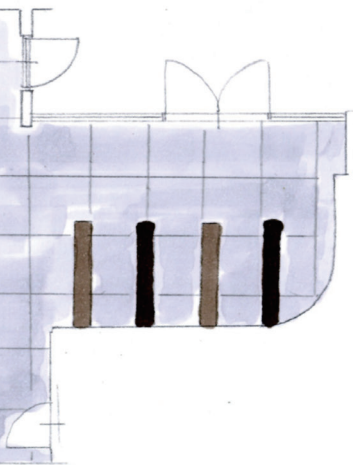

development

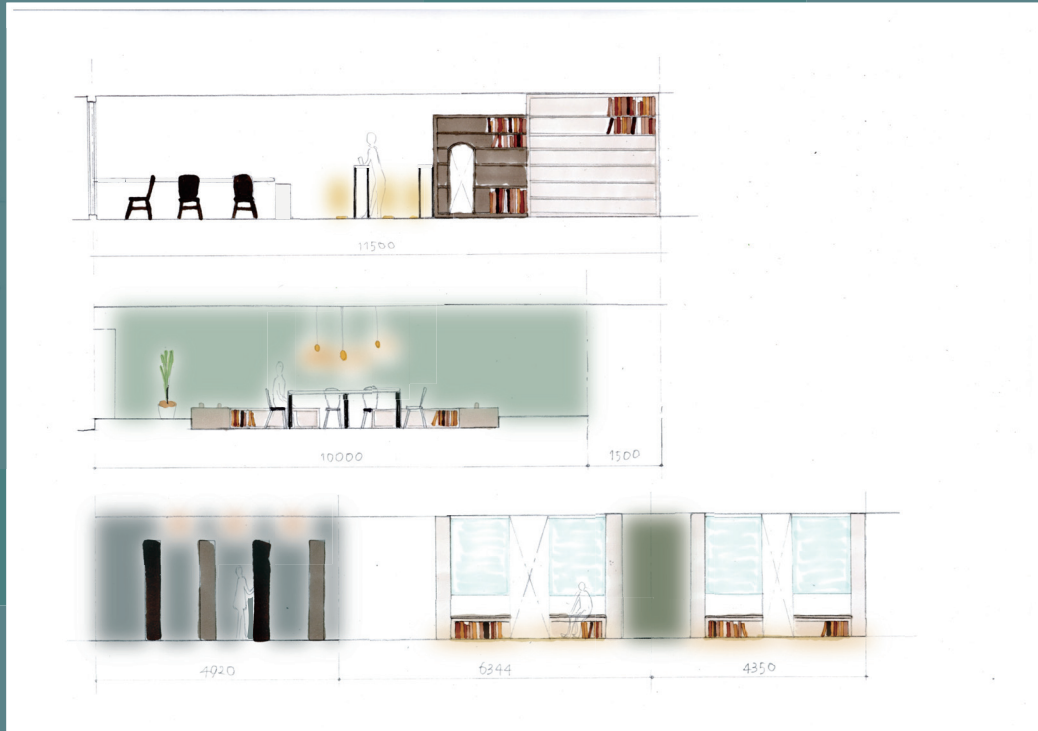
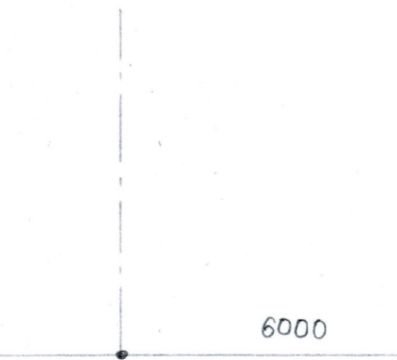

perth

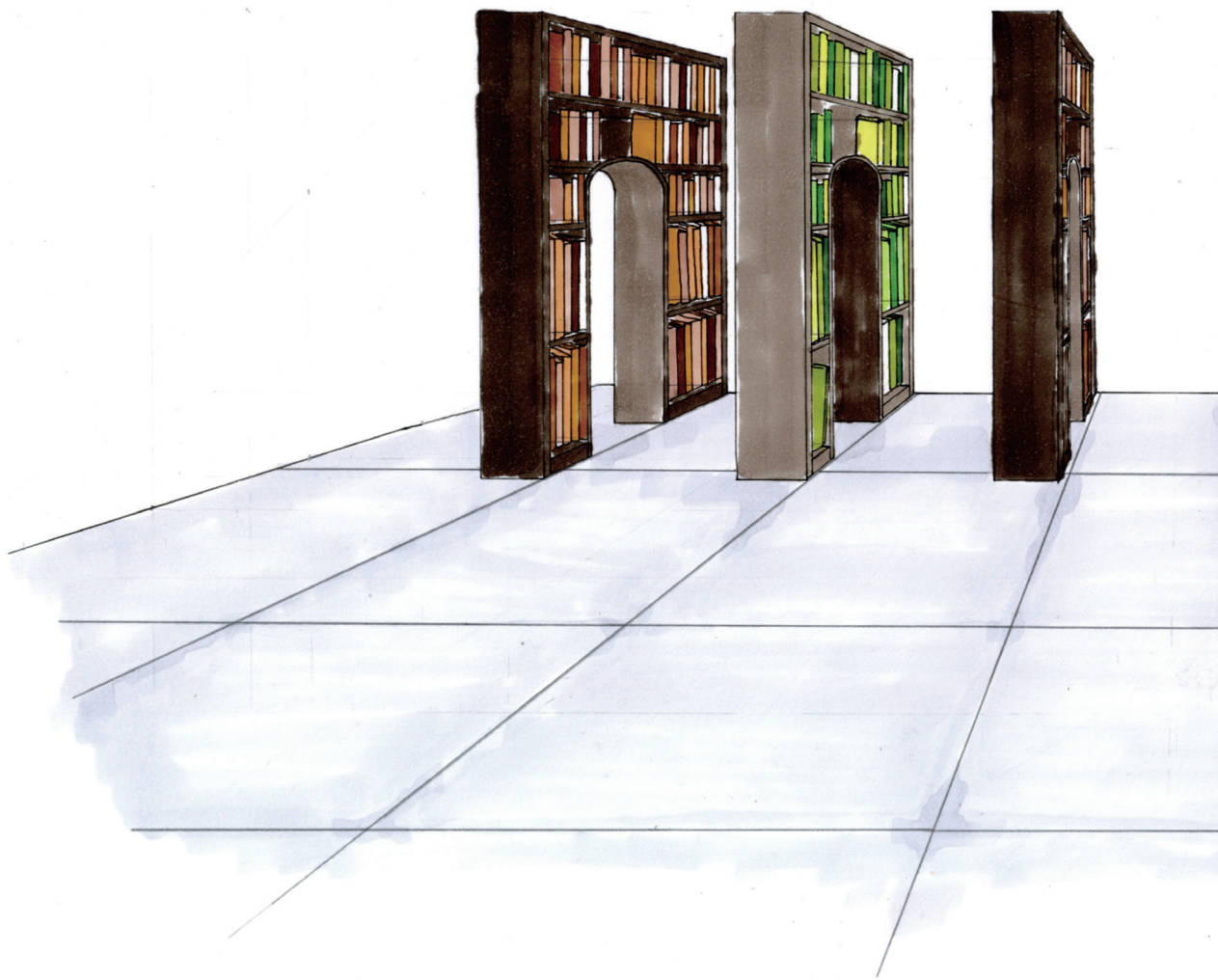

7

CAFETERIA AND 2000_DESIGN BOOKS

furni

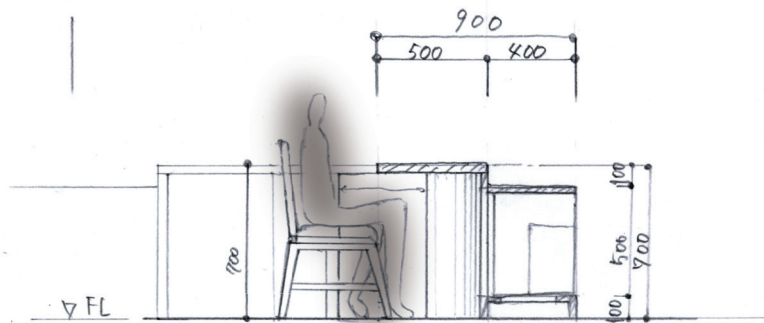
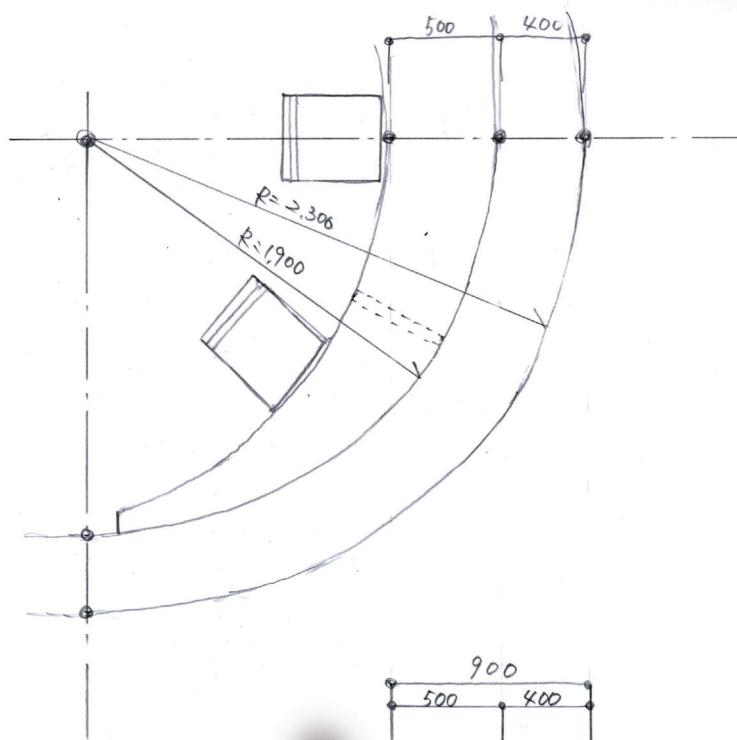

urniture detailed drawing

model



CAFETERIA
AND
2000_DESIGN
BOOKS

9

CAFETERIA AND 2000_DESIGN BOOKS





影からも水の波紋が浮かび上がる

川に石を投げて遊ぶ”**水切り**”を表現

11

water

水

water



東京デザイナー学院
インテリアデザイン学科 1d-b



mail:TDG21008060@adachi-gr.education
Instagram:@_momoeka

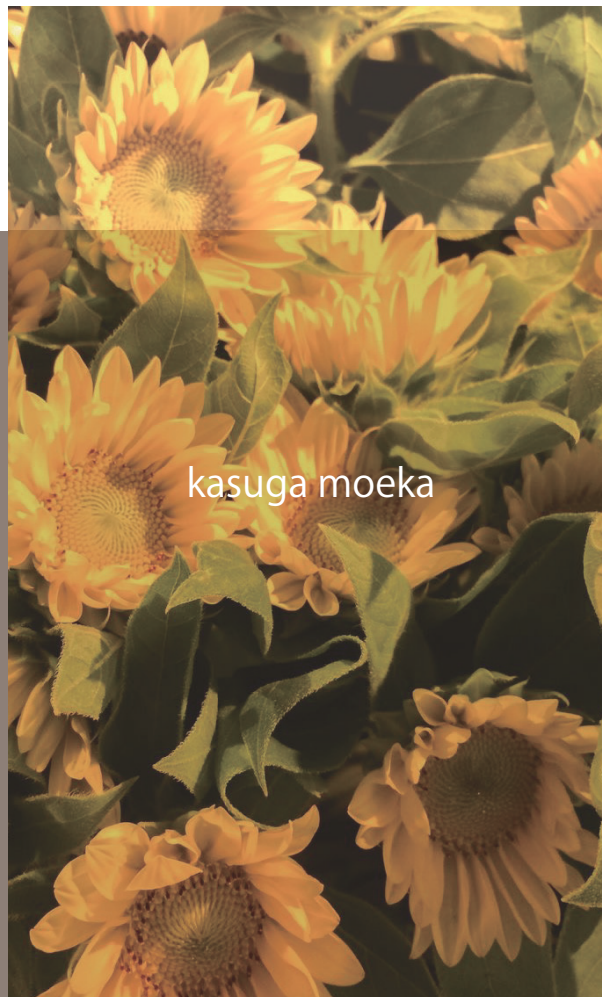

kasuga moeka

13

name cade

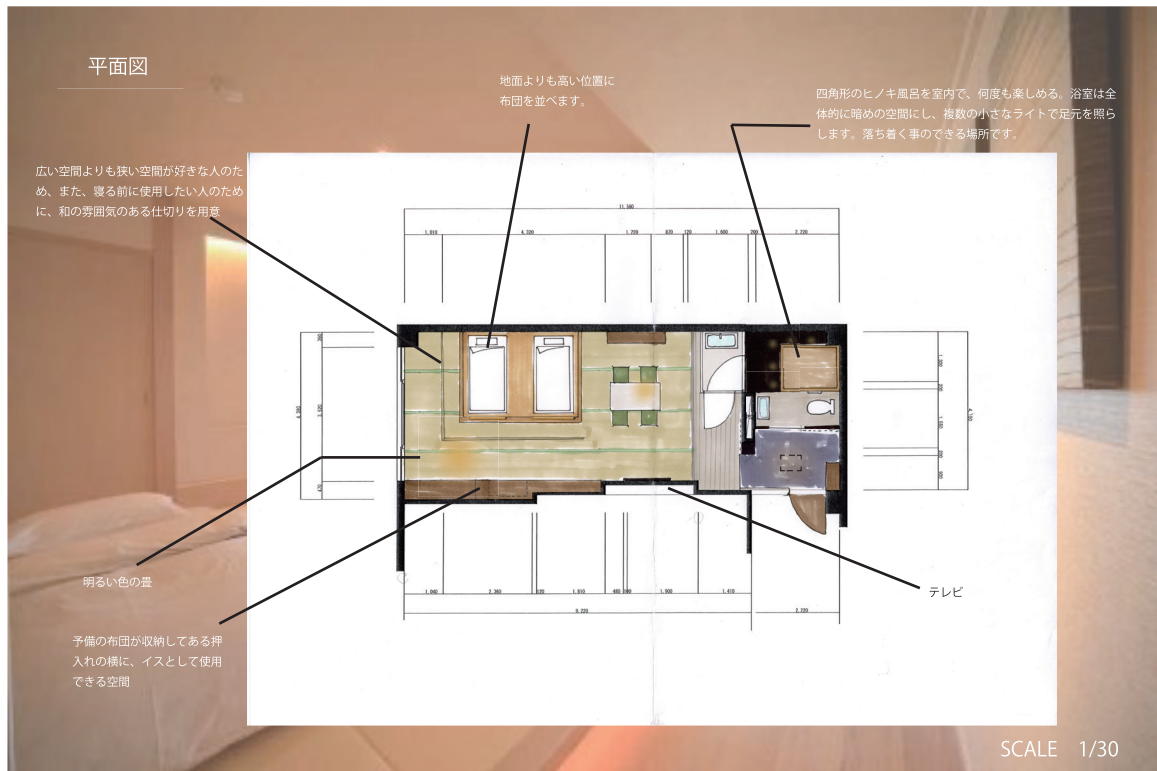

海辺にあるホテルをリノベーション
 大きな窓をつけて海が壮大に見えるように。
 そしてバリアフリーに優しく、幅の広い入り口、廊下、手すりをつけました。
 高級感のあるデザインになるように意識しました。

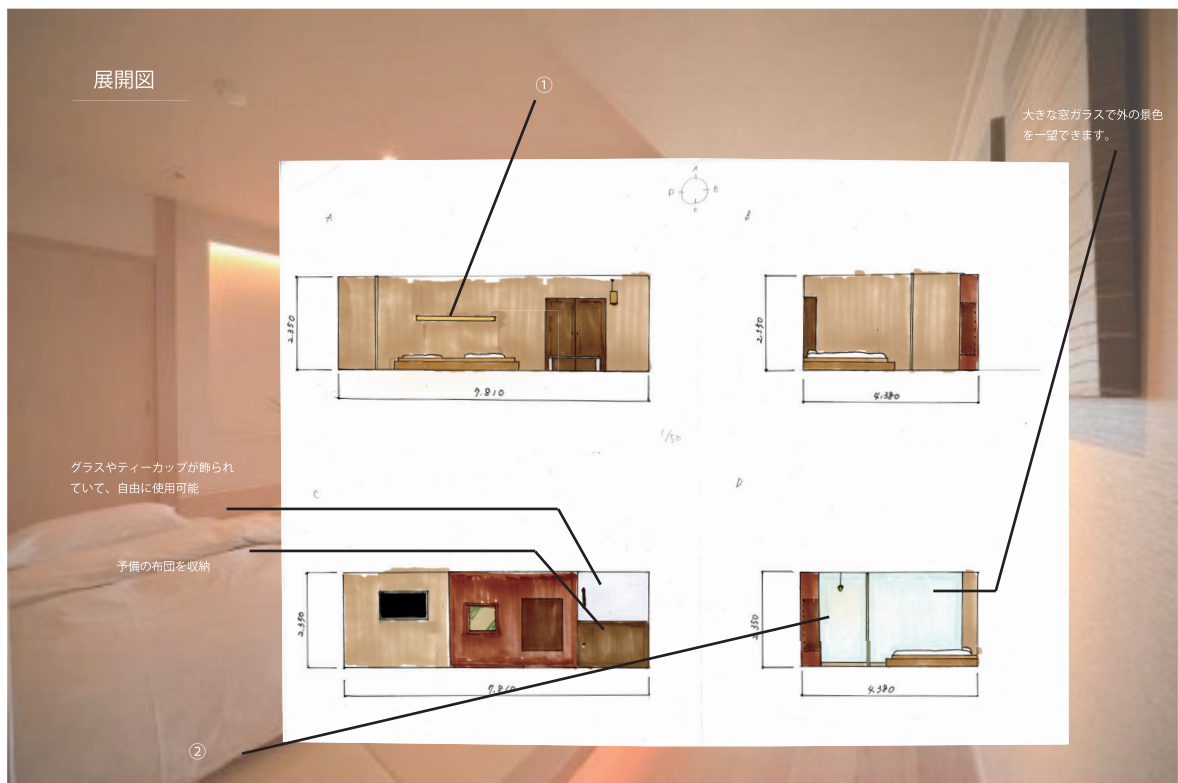

F
A
M
I
L
Y

O

f

F
O
U
R

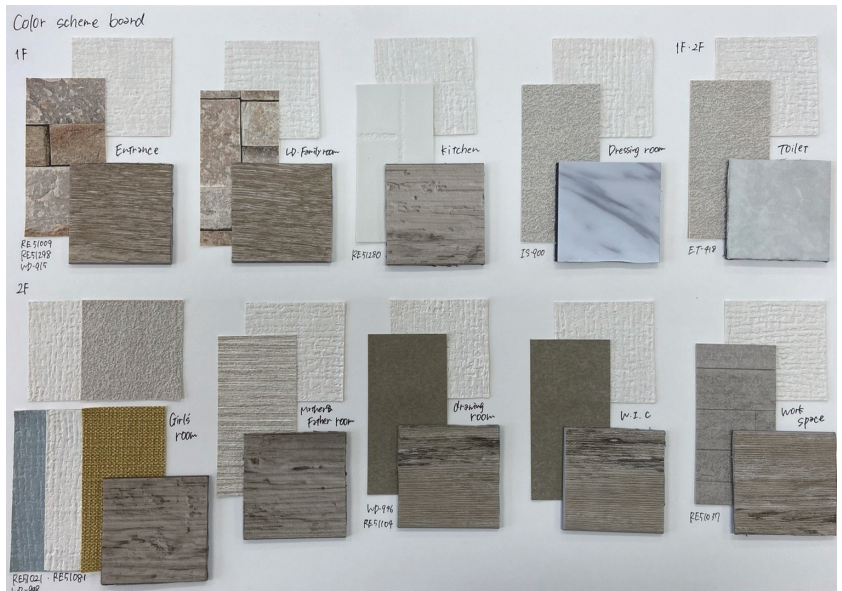
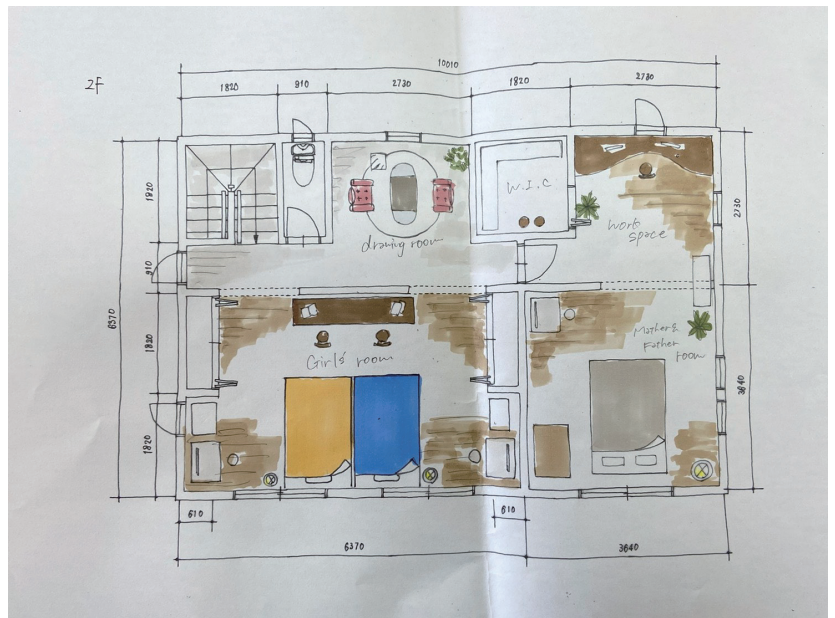
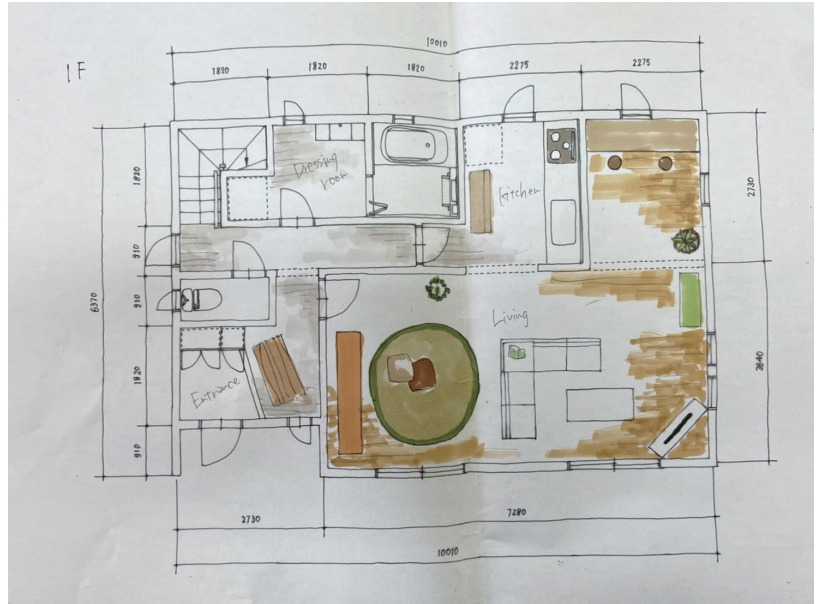

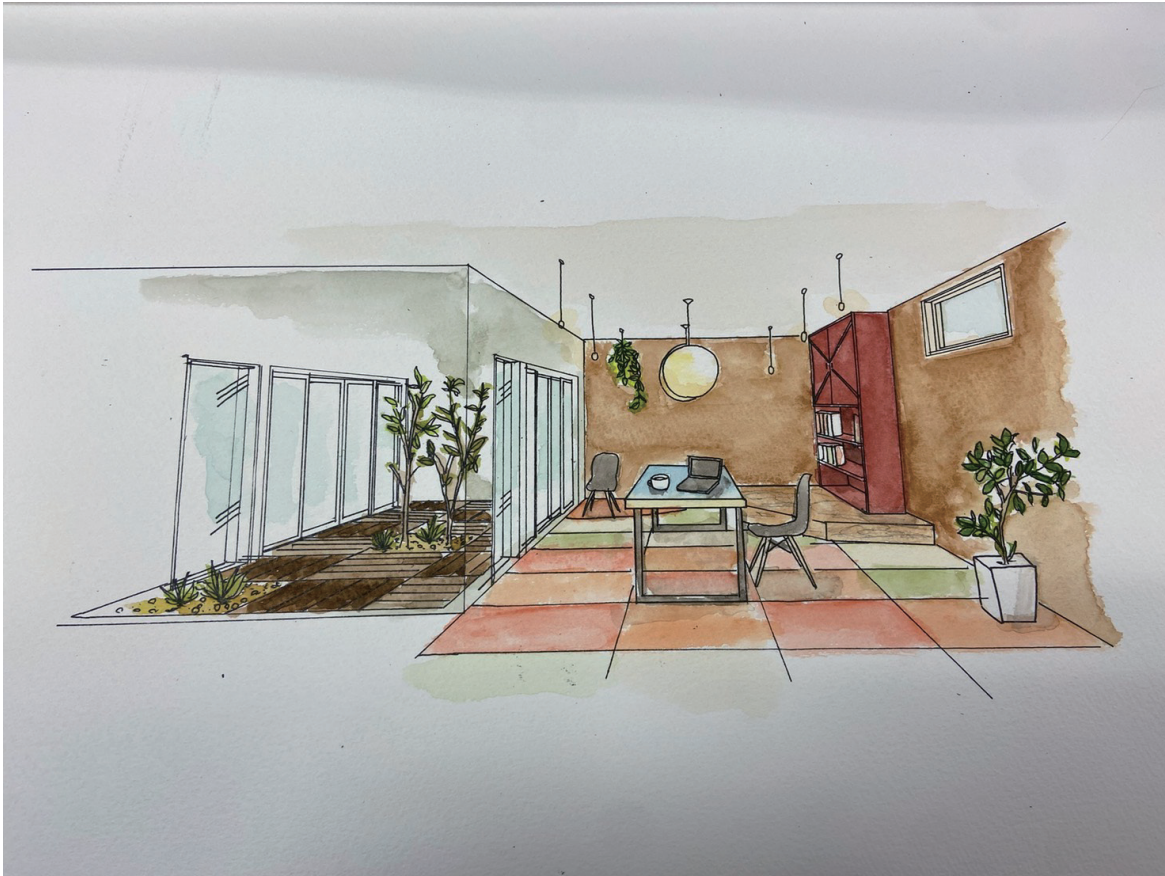

my office and shop



2021.09 ~

vector works
start

17

vector works

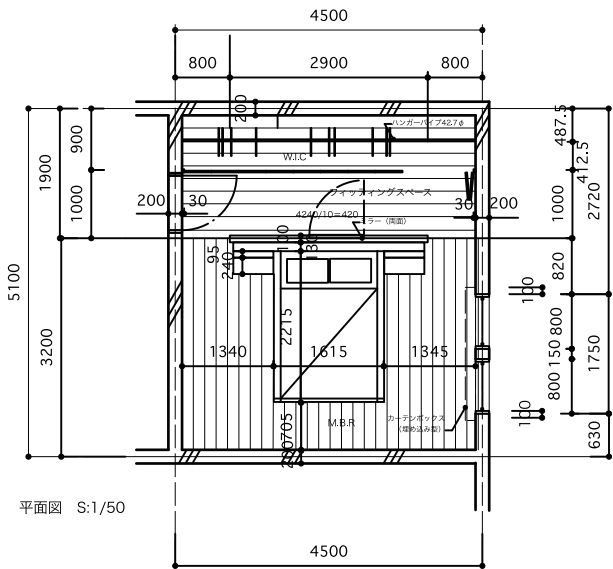

M.BED ROOM	
天井	ビニールクロス、下地 P.B. t-9.5
壁	布 (麻) クロス、下地 P.B. t-12.5
巾木	木製巾木 (ブラックウォルトナット) H=100 O.P.
床	複合フローリング (ブラックウォルトナット) t=20mm W=170~180
備考	棚板、及びナイトテーブル:ウォルナットつや消し サッシュ:開き窓1900×800(H.W.)

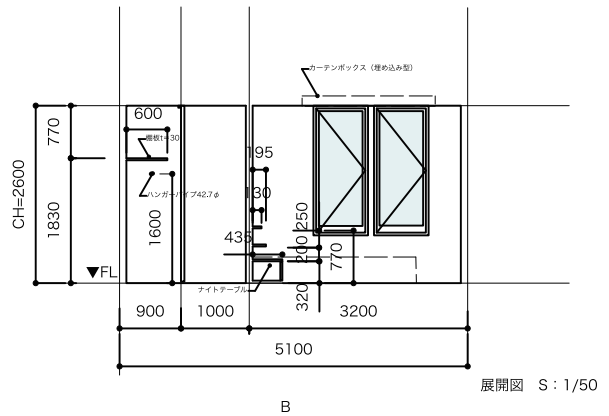
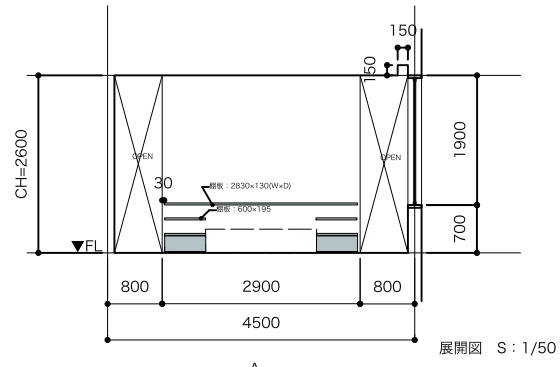
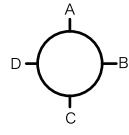

シャッター通りを
町屋デザインホテルに

image

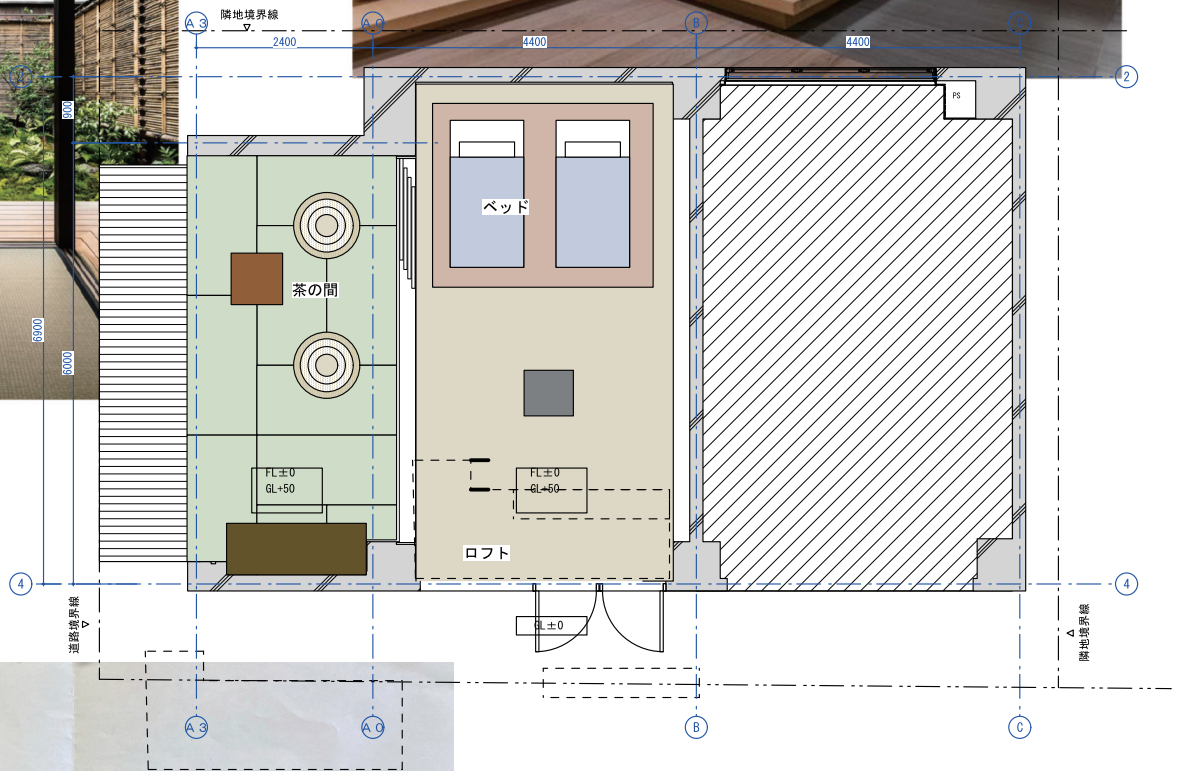
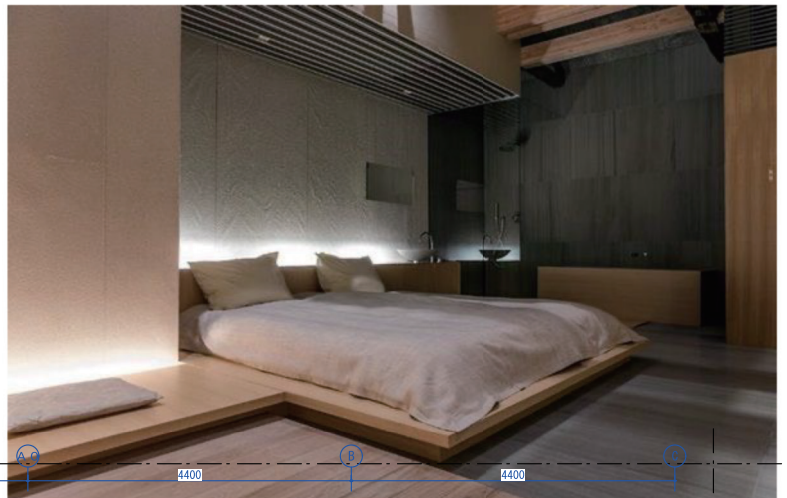

着物をきる体験のできる
和風のデザインホテル。

子供が休みの日に遊びにきて、写真を縁側で
撮って楽しめる

ホテルでその町のお土産を宣伝

シャッター通りを子供を対象に活性化させる。

19

shutter street

