

ホスト7リオ

C. 32 (7+12) 1/4

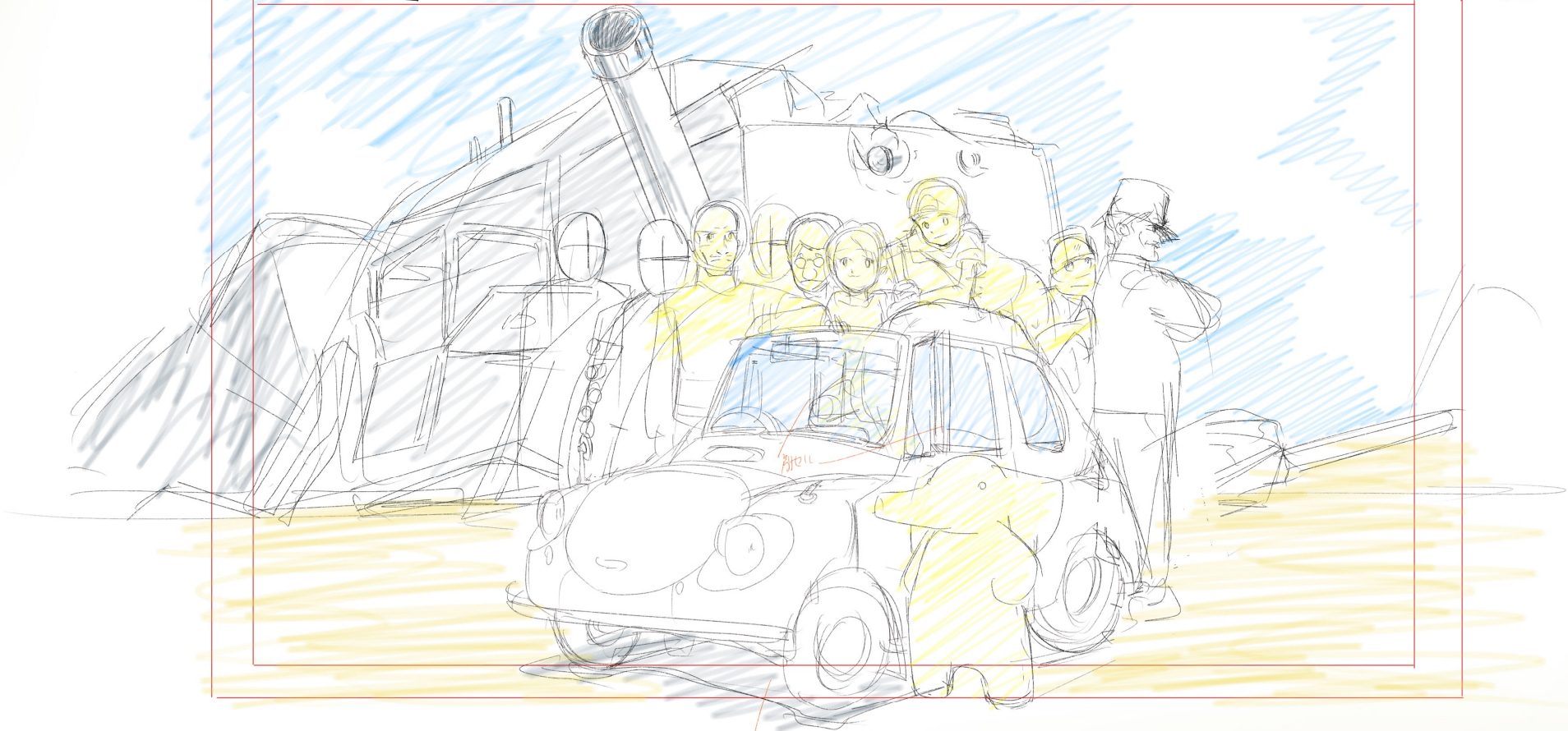

wis

藤本温稀.

この山に城を築く
には、石を運ぶ
手段が必要



石を運ぶには
この装置が必要



この装置で石を
運ぶ。

城下街

この山に城を築くには、石を運ぶ手段が必要。この装置で石を運ぶ。城下街。



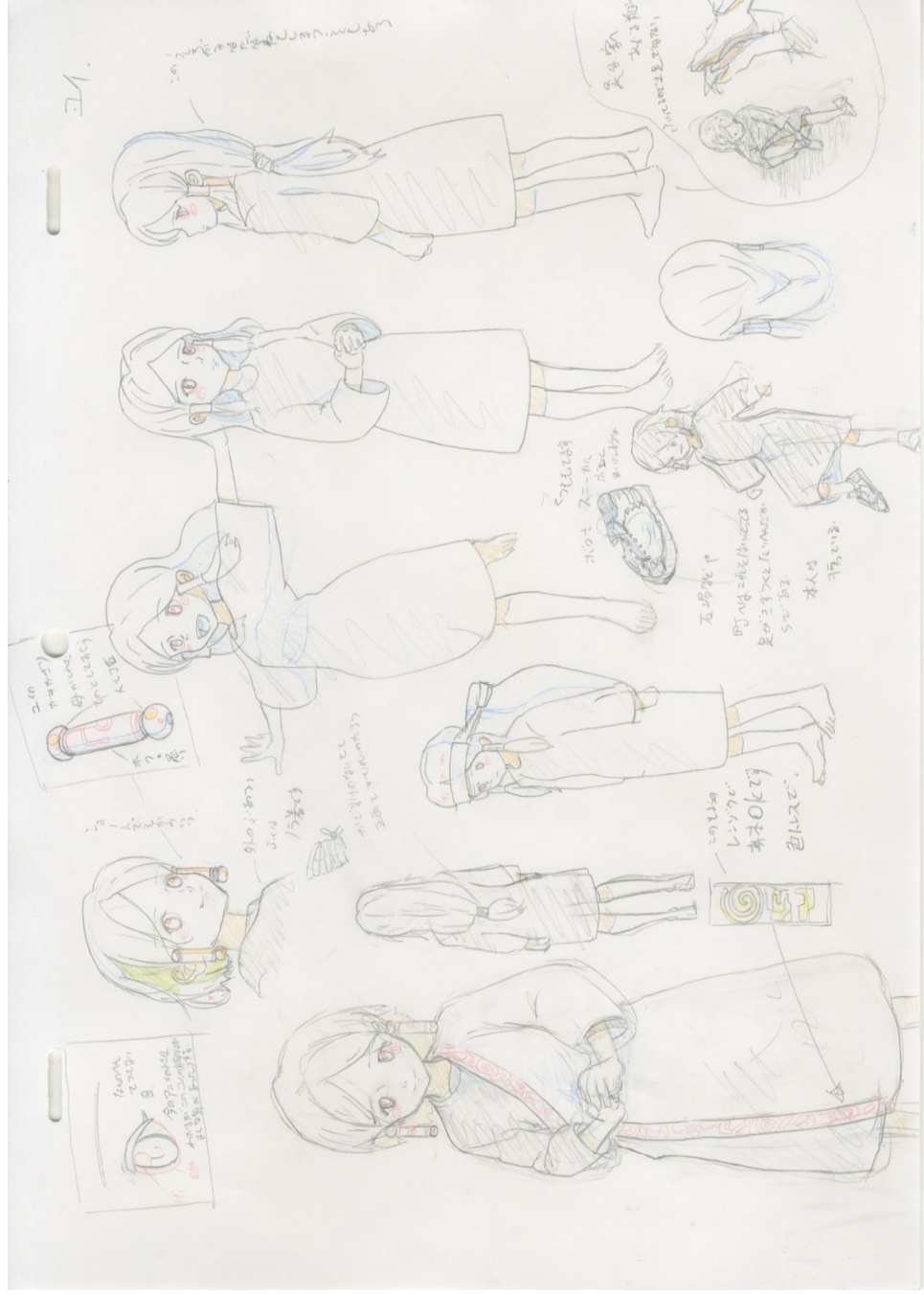
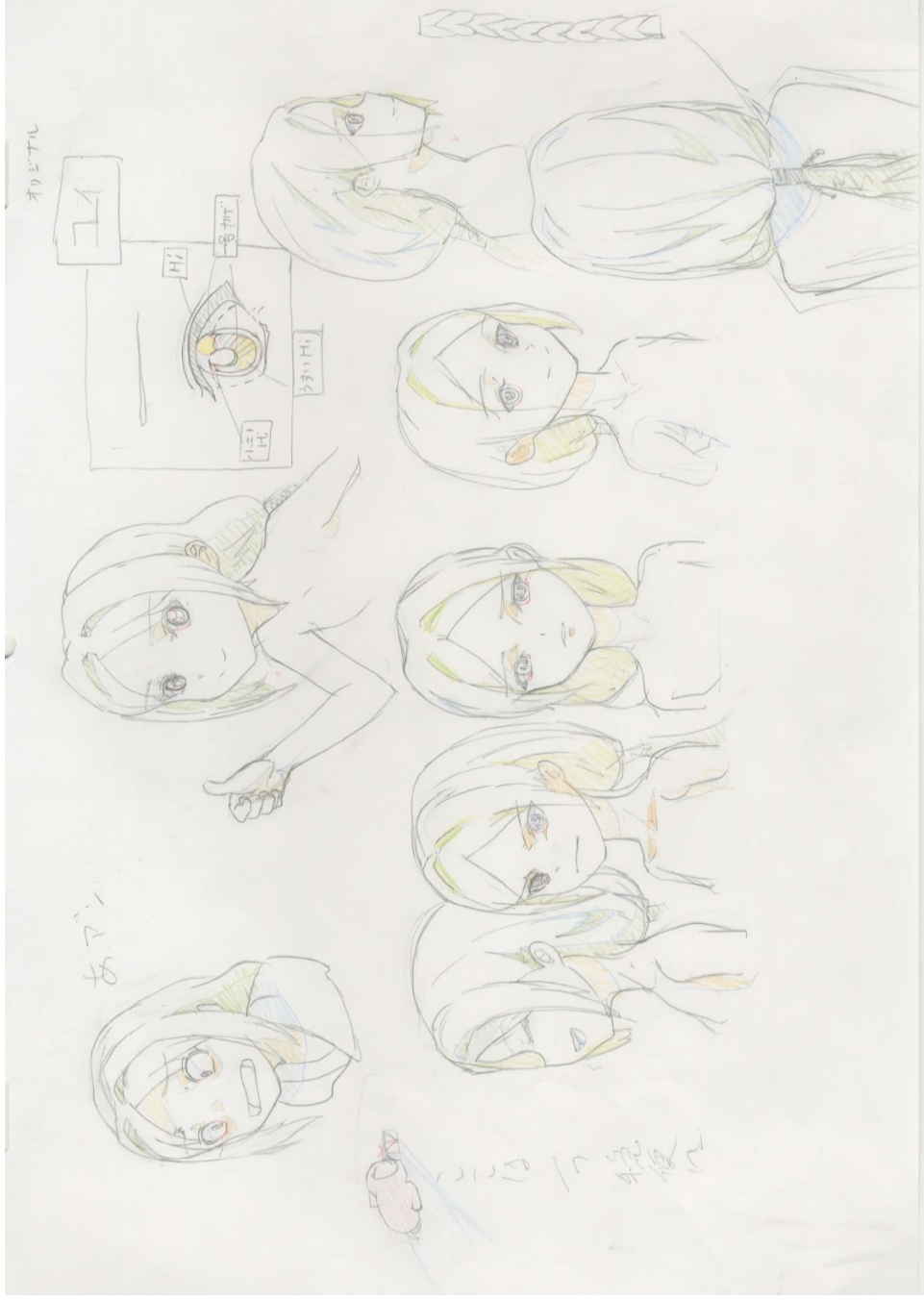

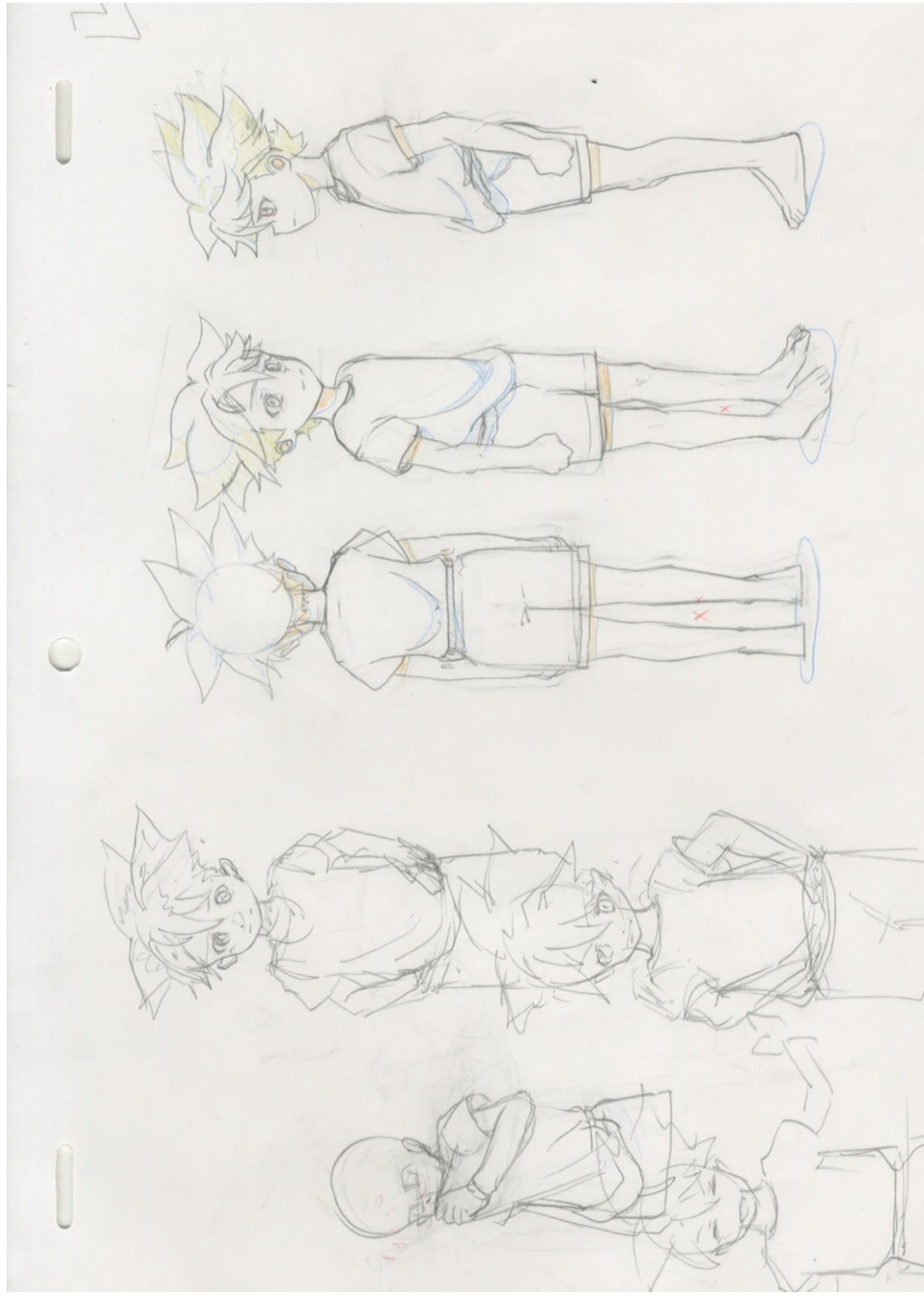
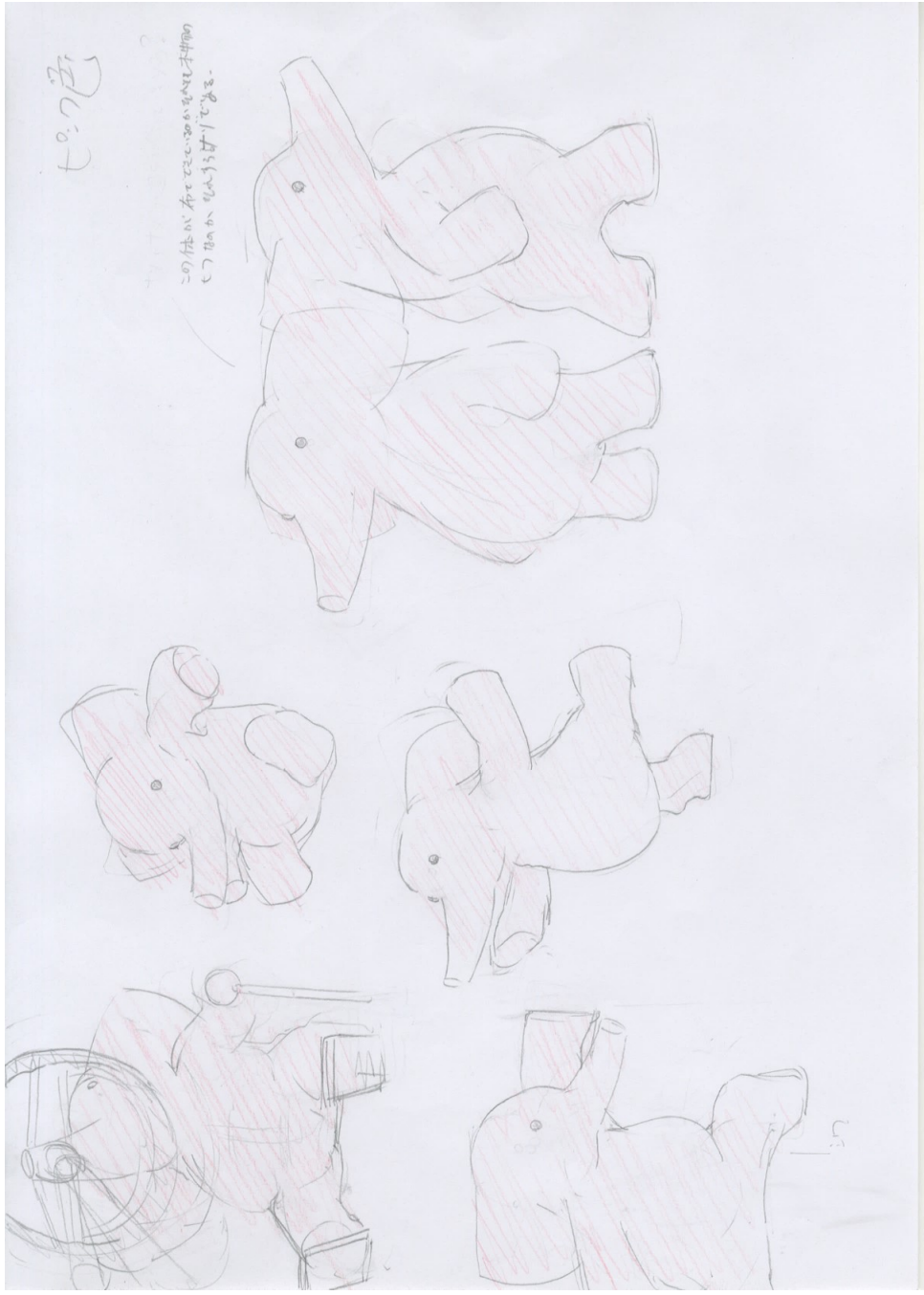

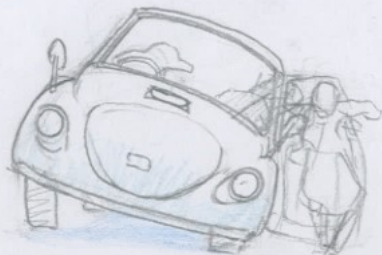

フニル
360
E社.

フニル
E社.

フニル
E社.

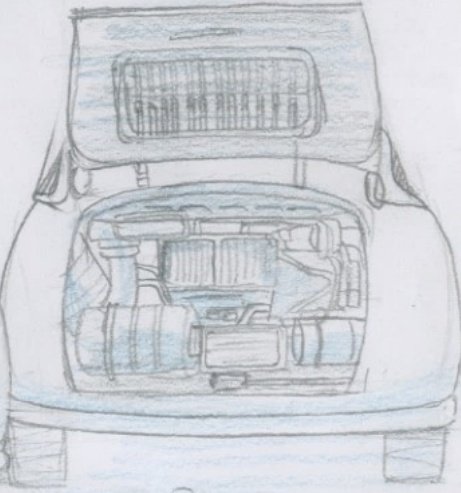
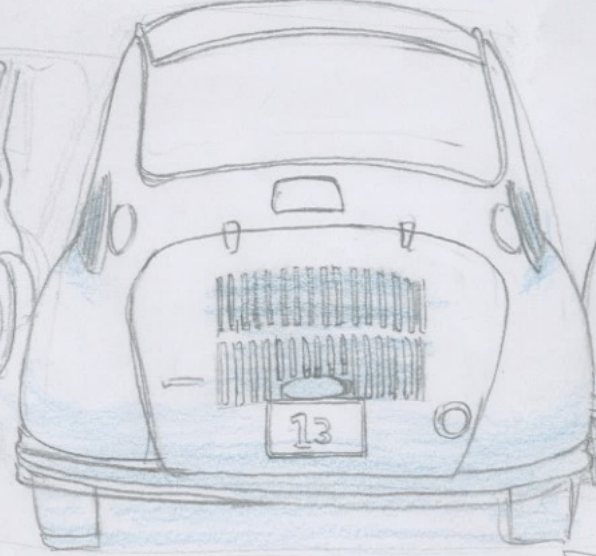
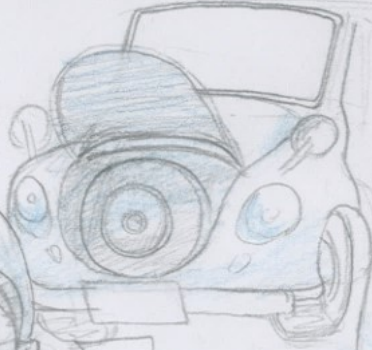
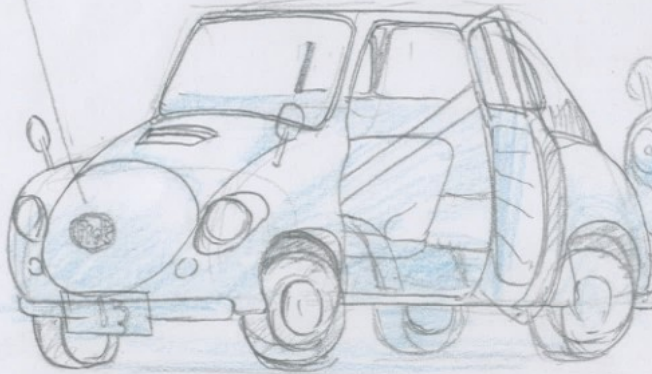
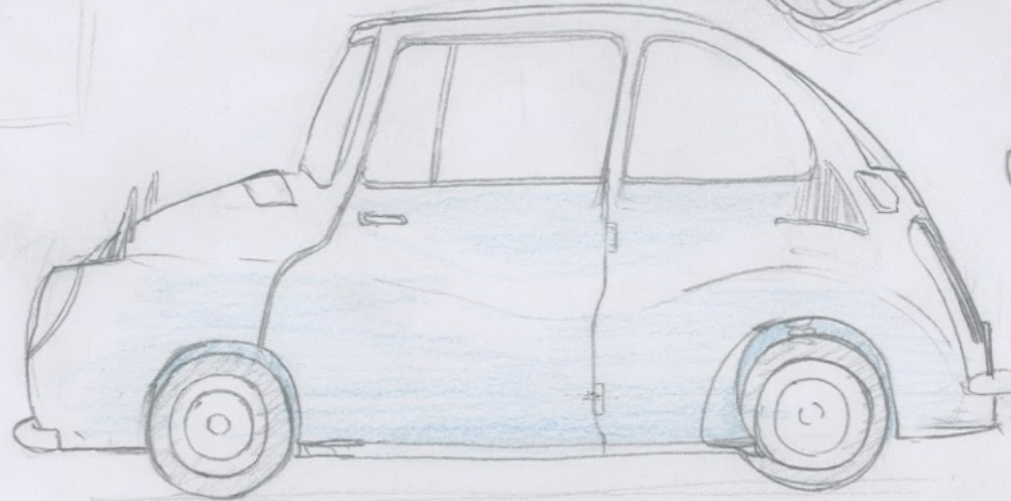
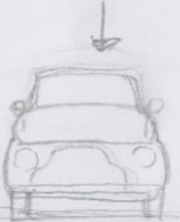

パ
E

パ
E

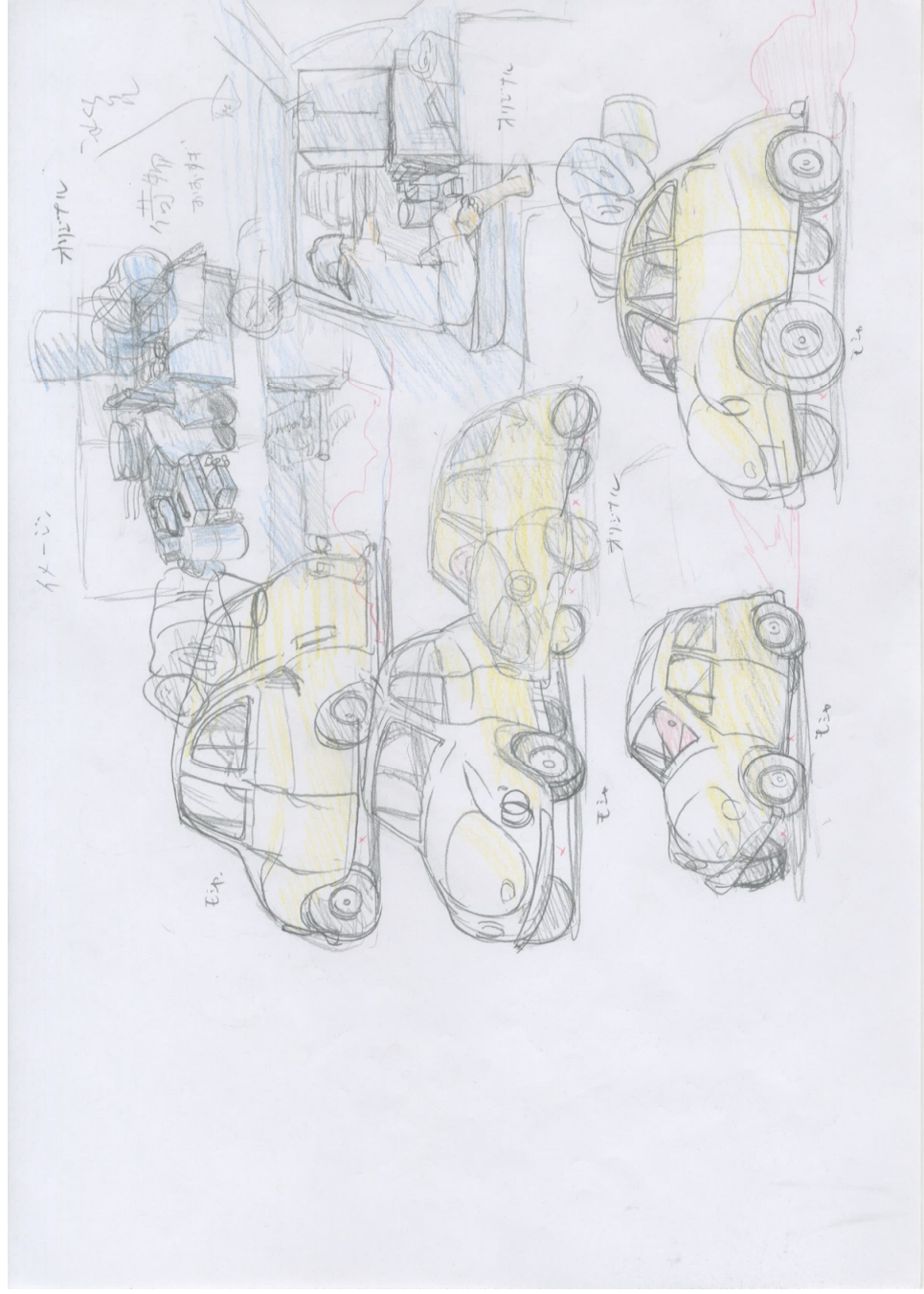
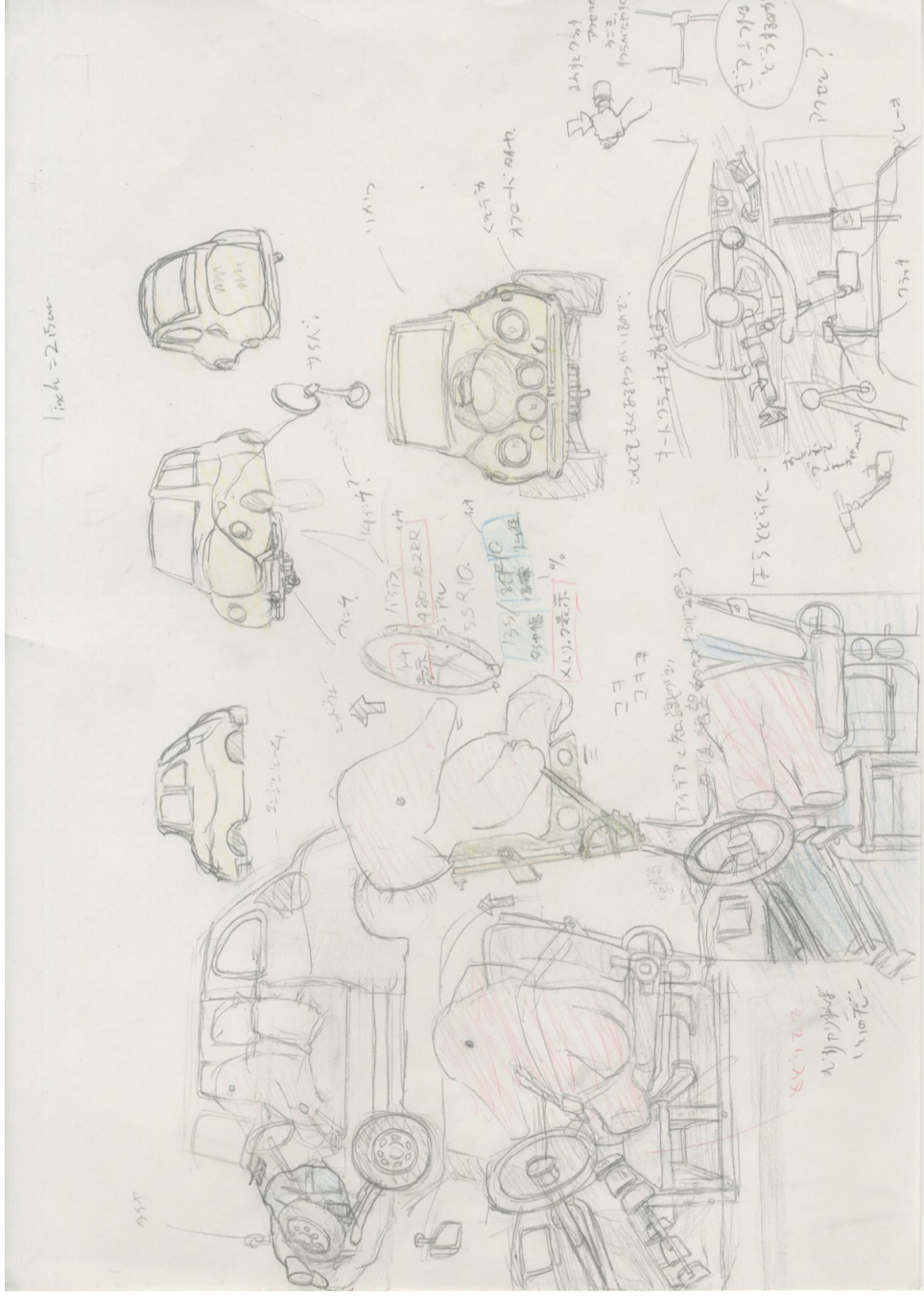

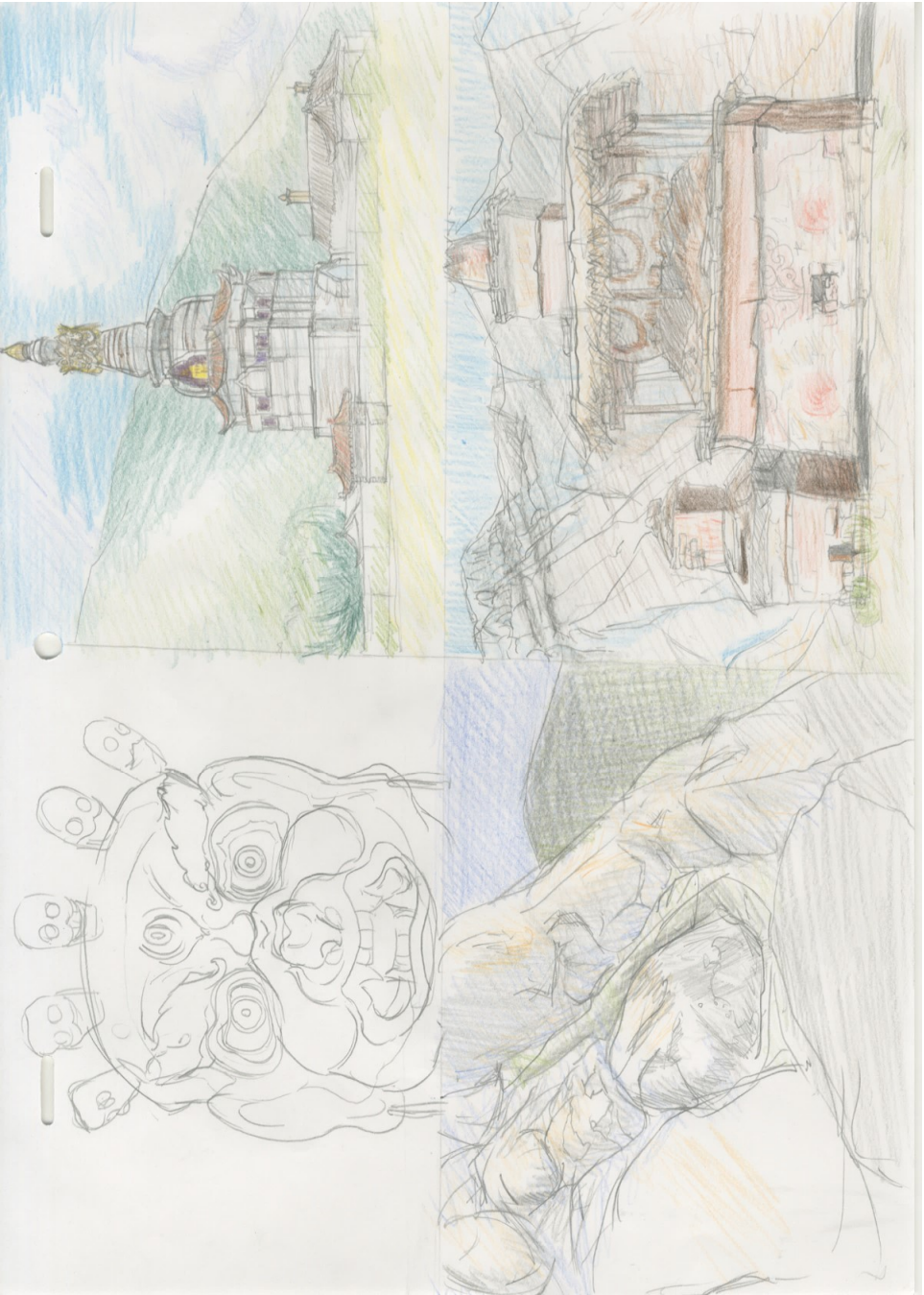

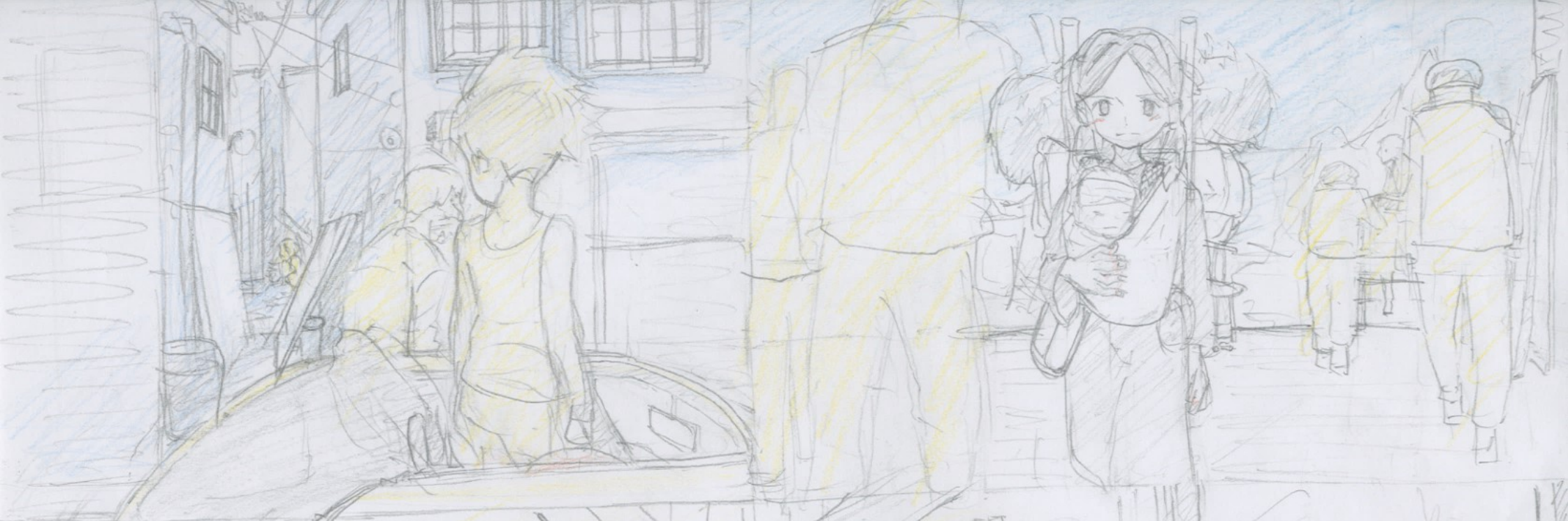

こわ
ボツ

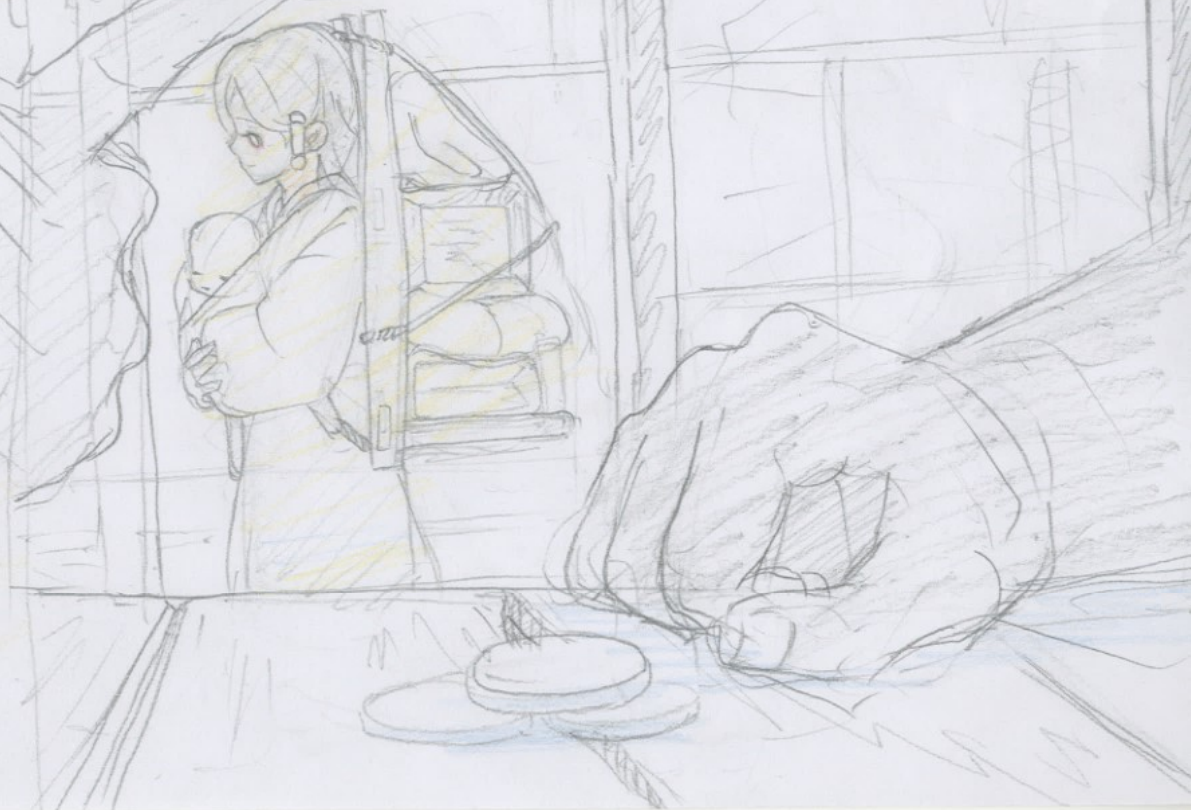

全世

As. パース

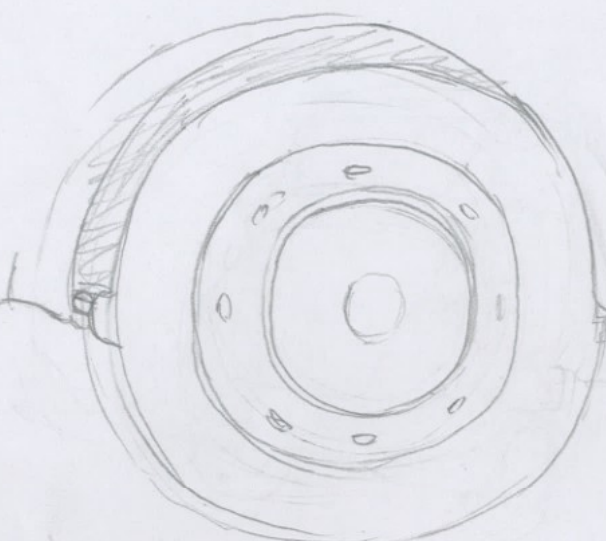

ハートの

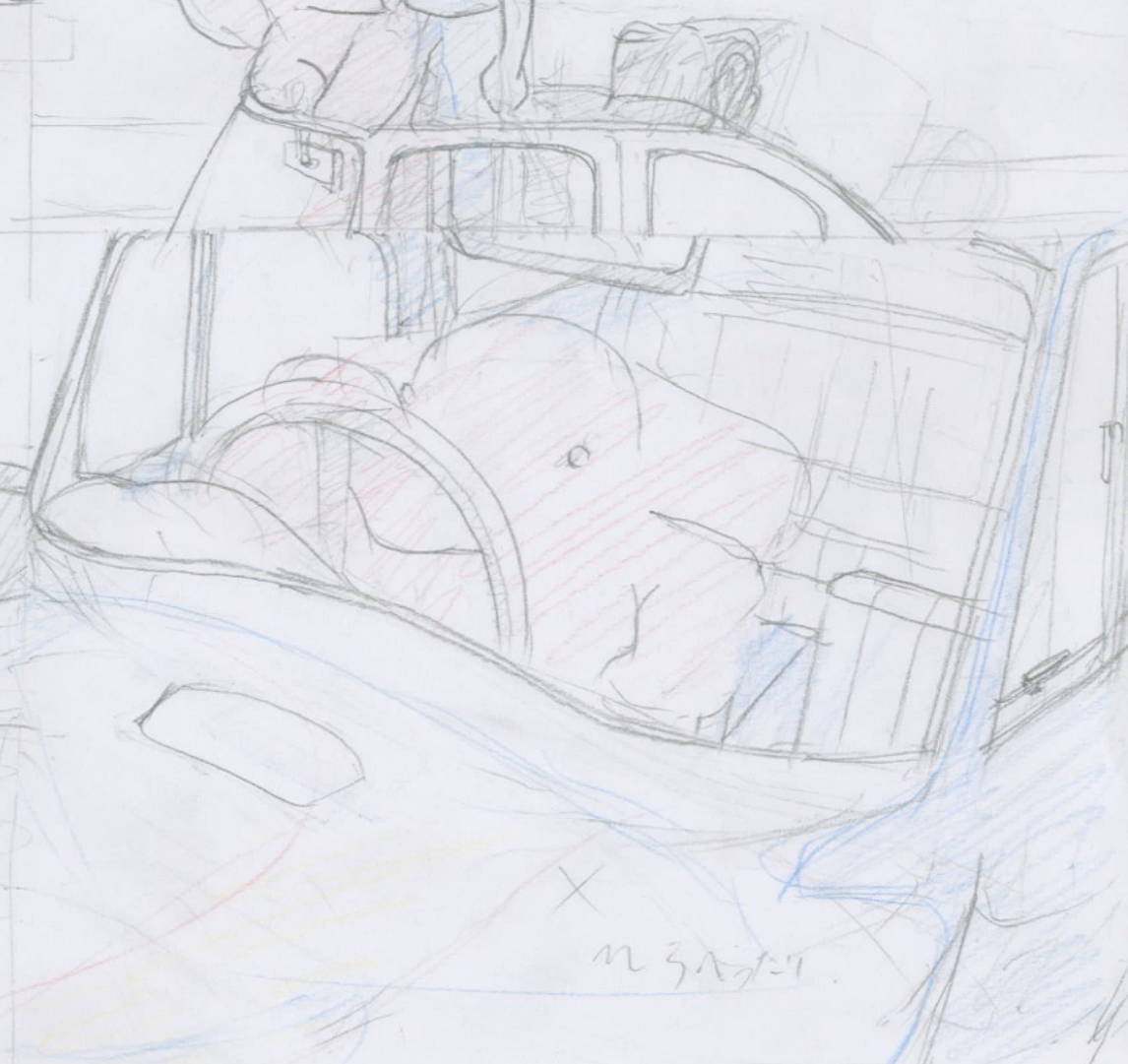

23/1/11

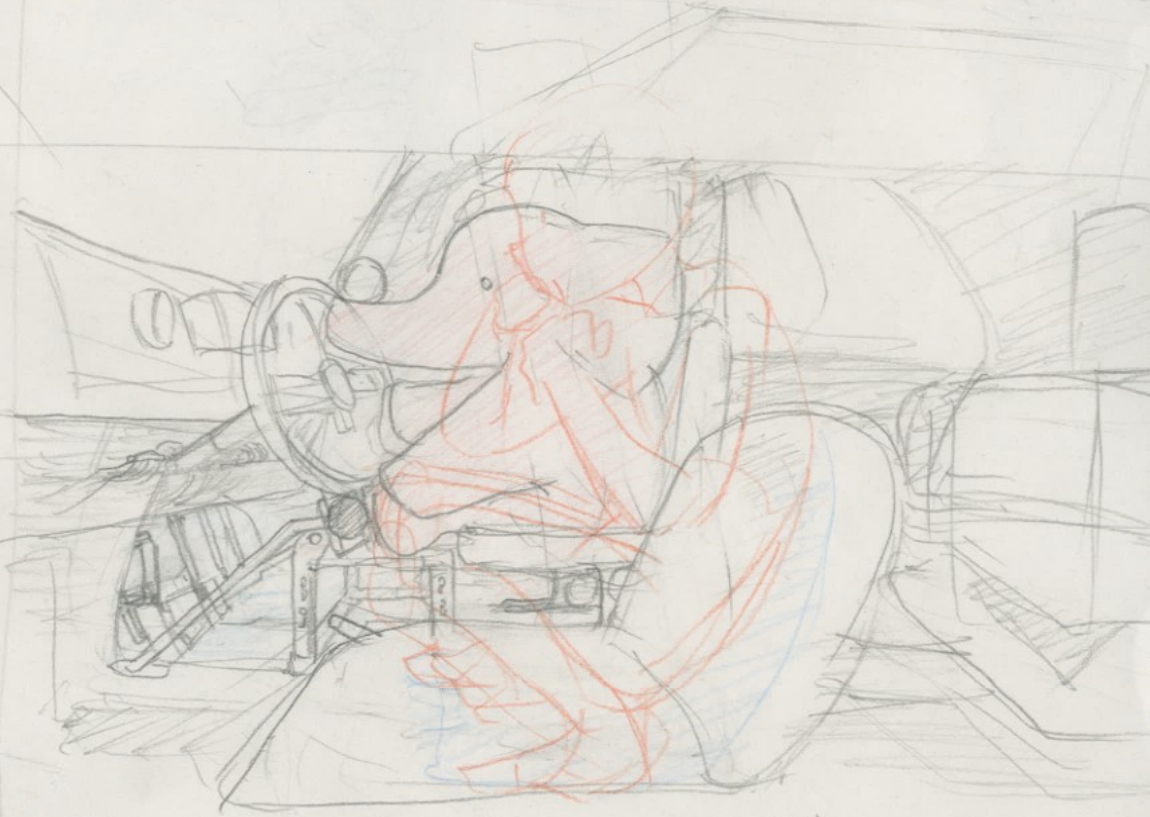

しんばあさん。



カリゴ
リク
と
カガク



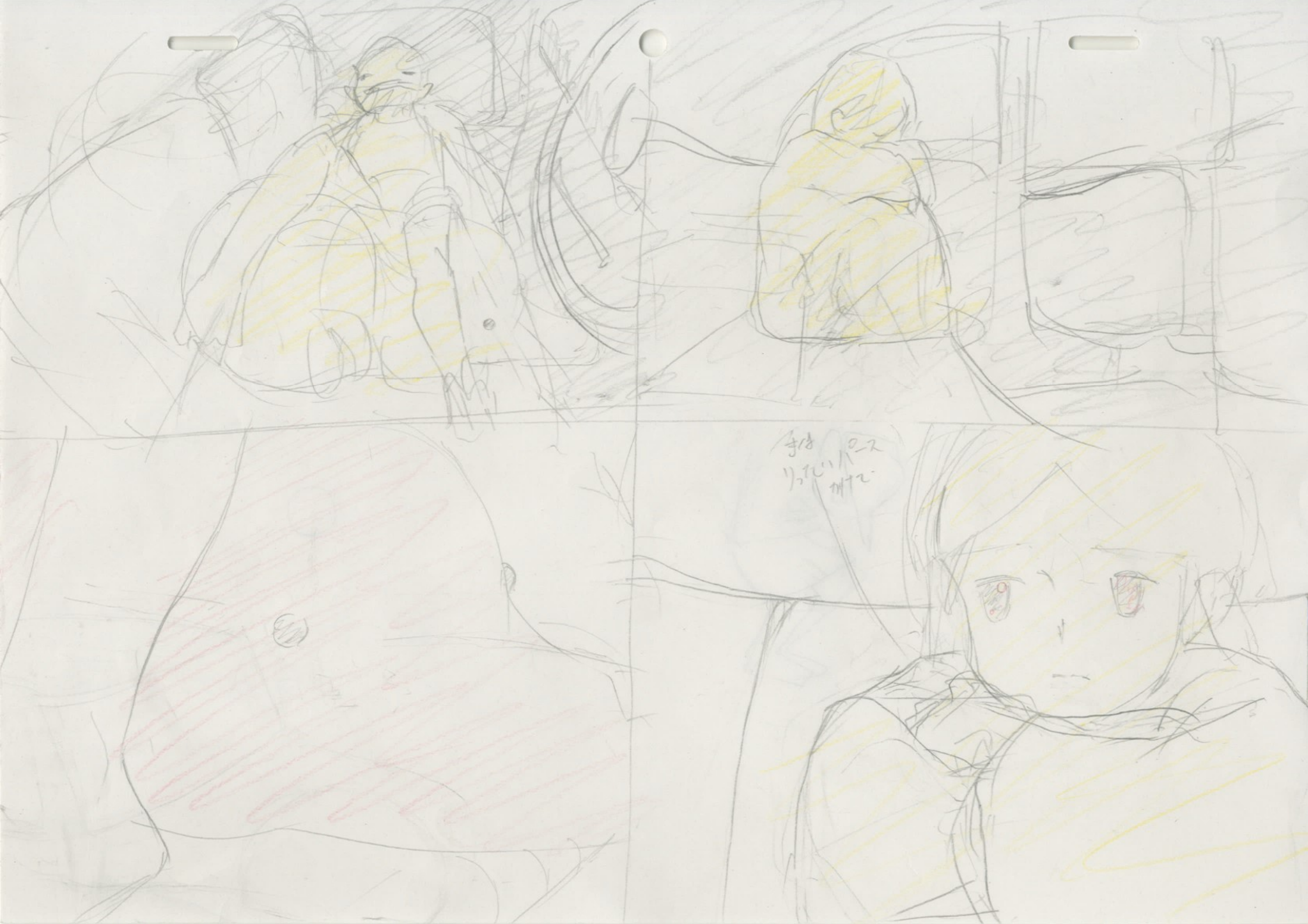

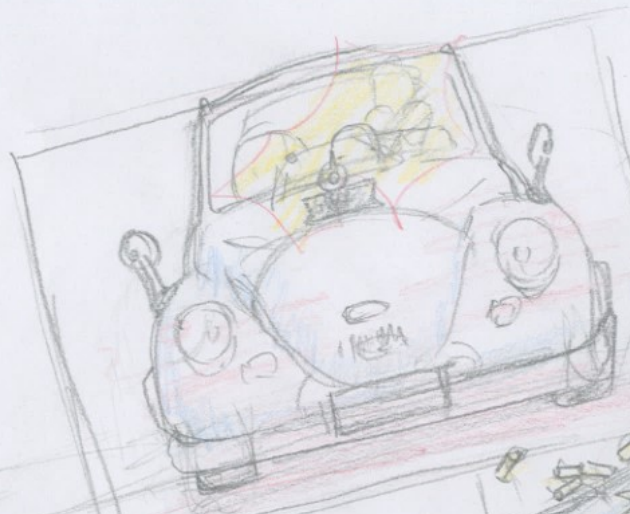

TM 436.
A: 76-91-70=5

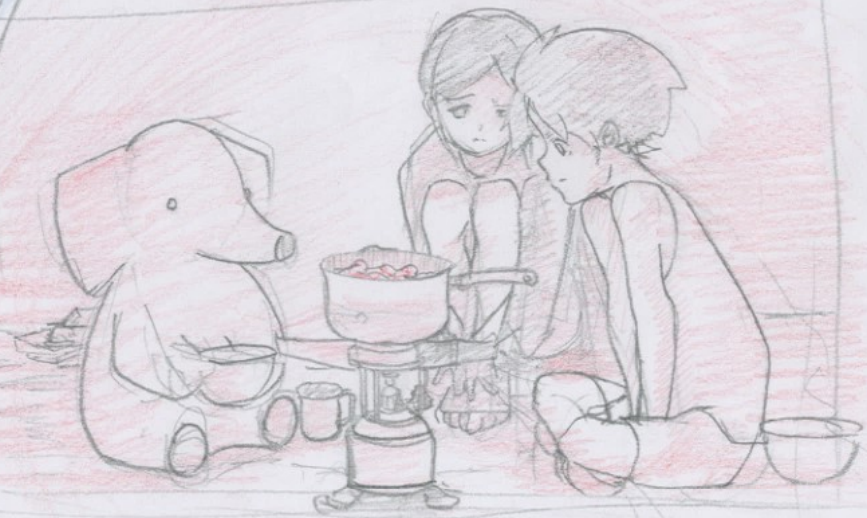
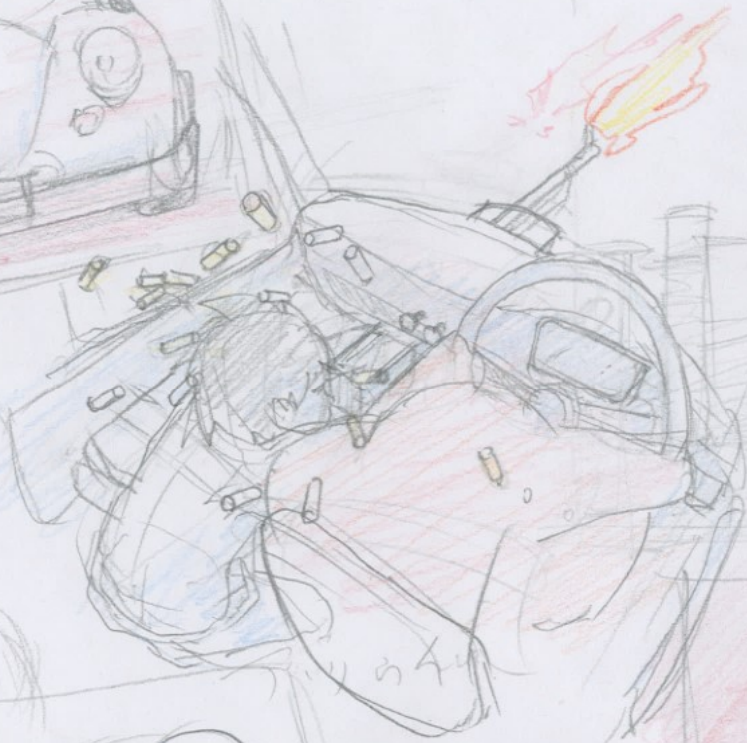

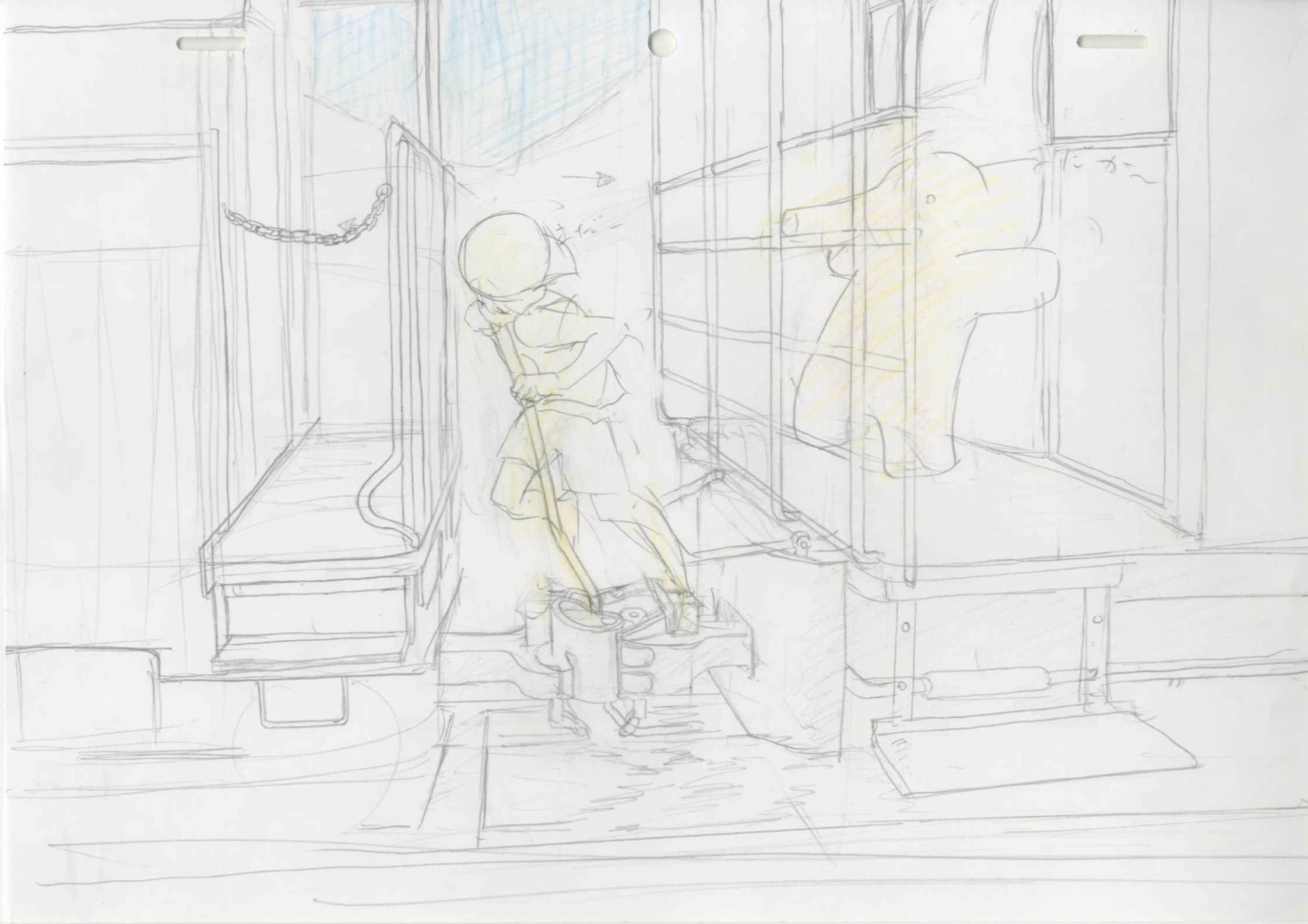

Lat



5

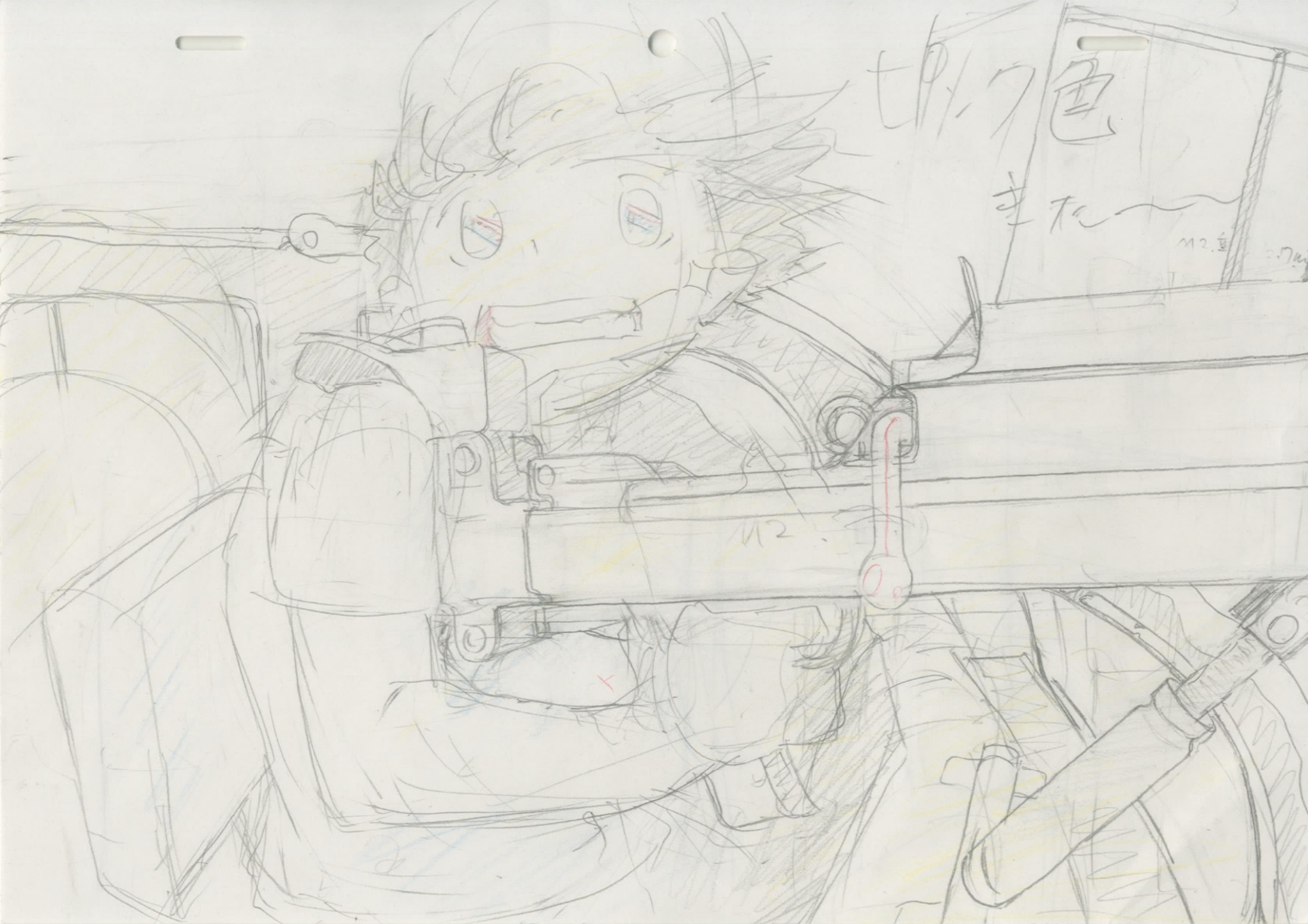

七色の

まは

112

x

0

in

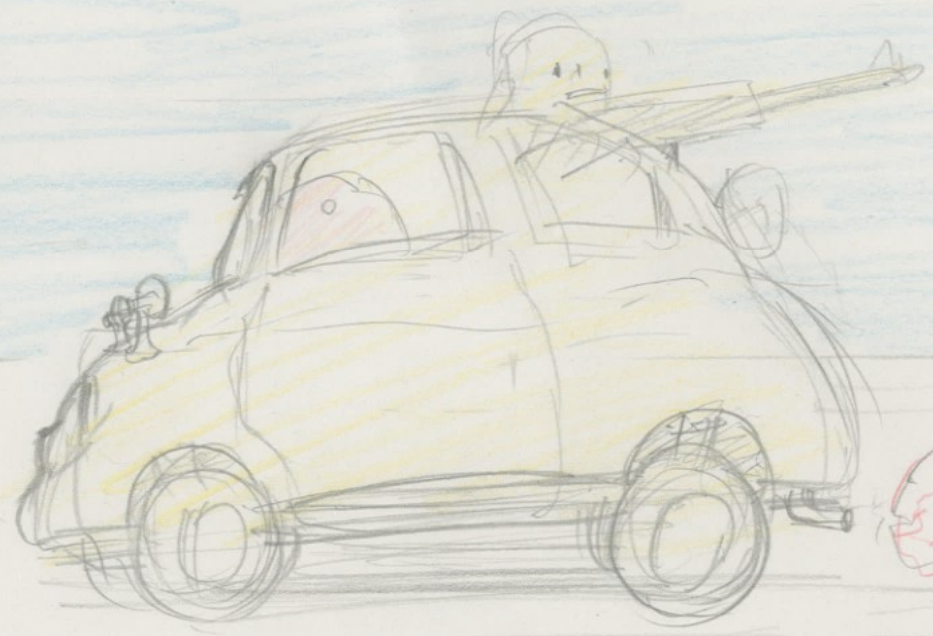

in



水平
の
位置



ボウとピンク色キアチニ

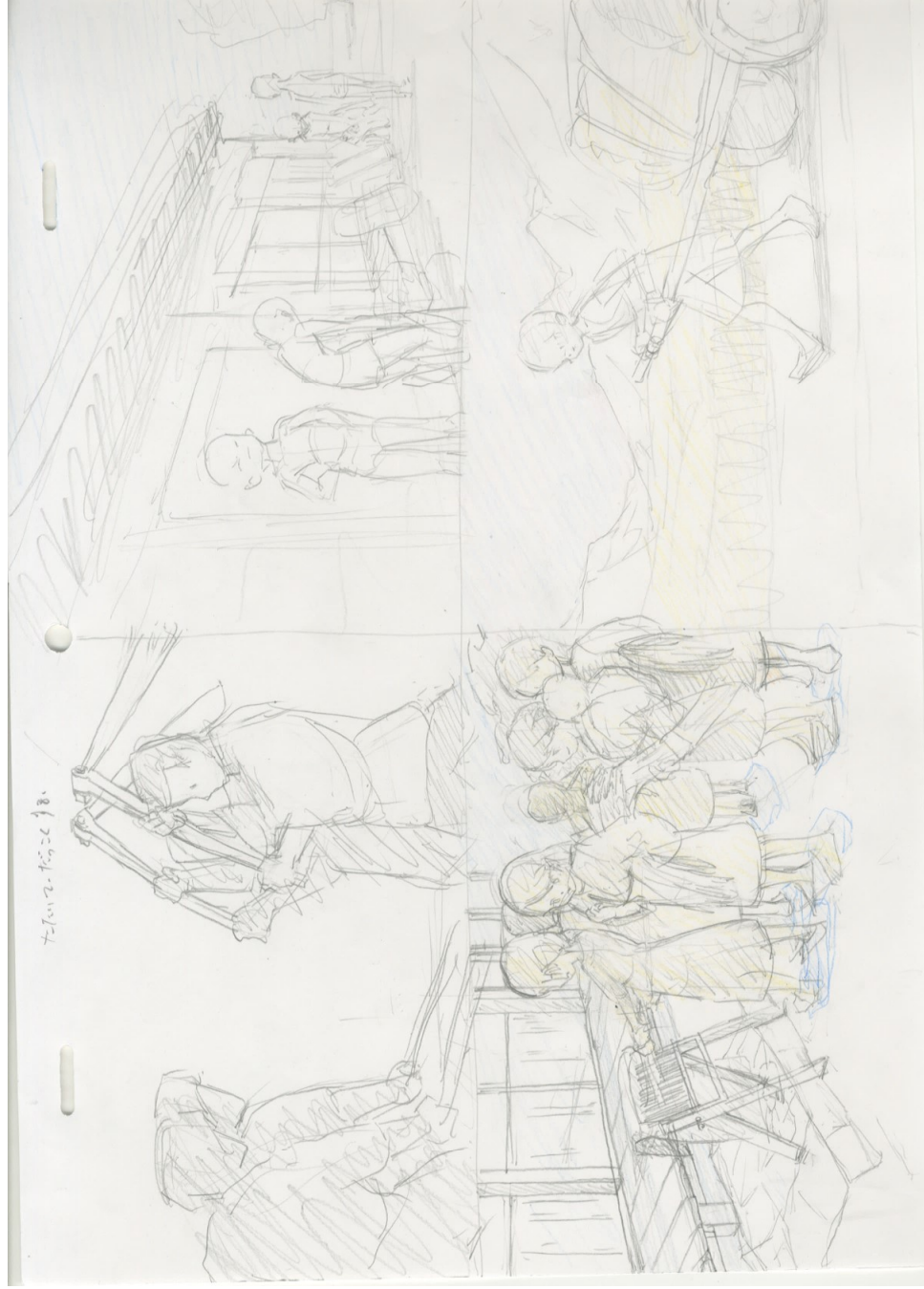
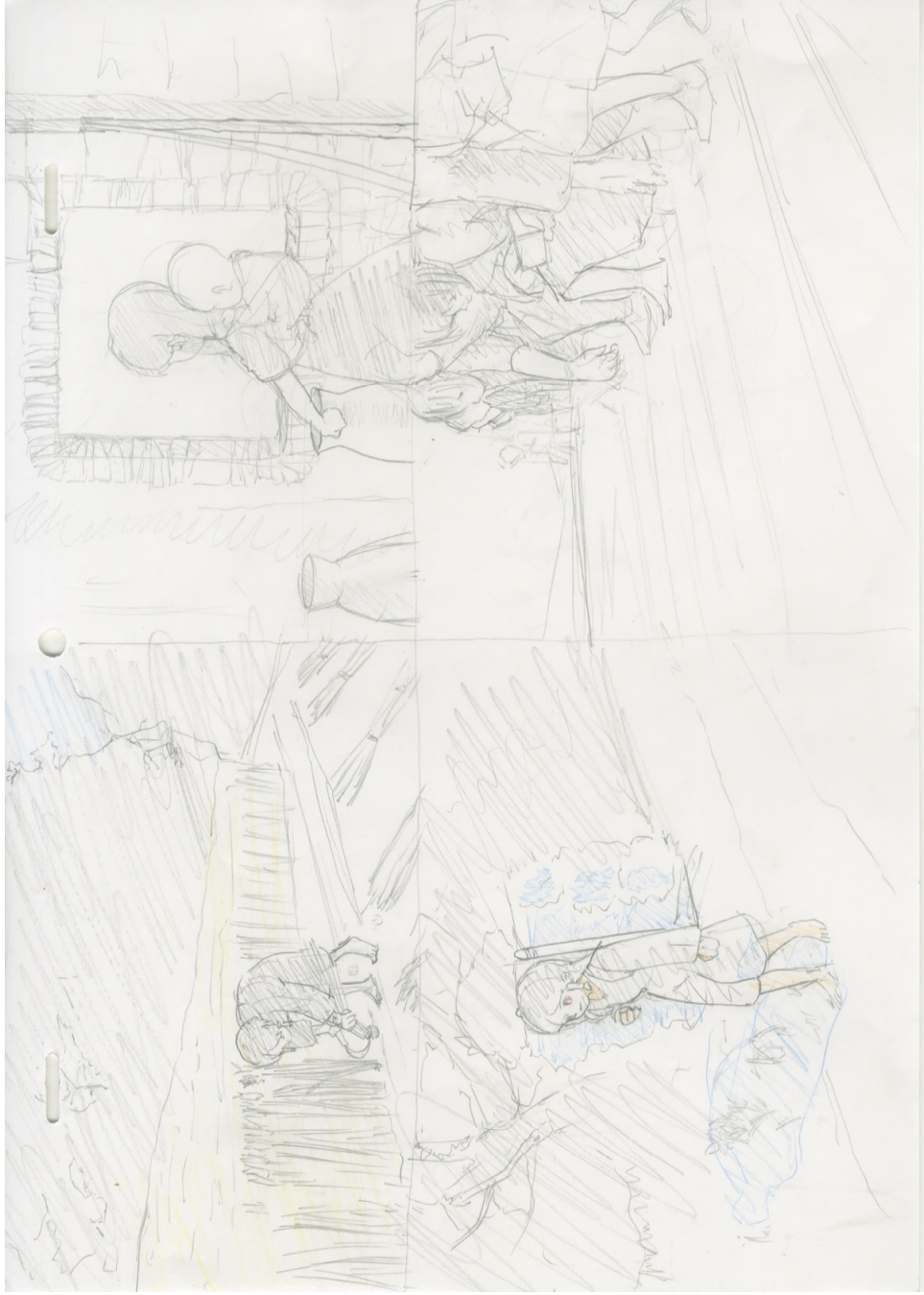

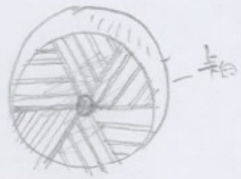

2550 44411
T.O.L.C. 444



ヒヨクノアト
4002
1851672.03 27/2

175-770430713
7011
8-



乳製分油
油
油



大麦
2000



おとく入量に
おしゆえん(た)とす



T.O.L.C.

てんぱた-は
たのこ 4202 1671



鐘水女街



いもれ

2つと
1はでわ 下着のおぼれ

ALC シパン

モてじの
はかた

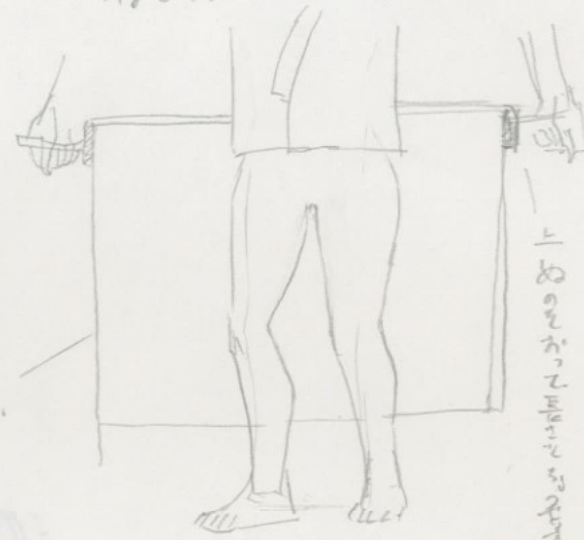

ゆるいものもある

腰ま

上めをたてて腰まをゆるくする

折る



0 5分 1R

2R 8分 5分

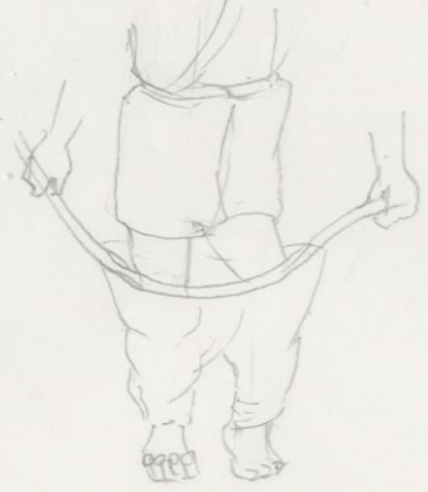
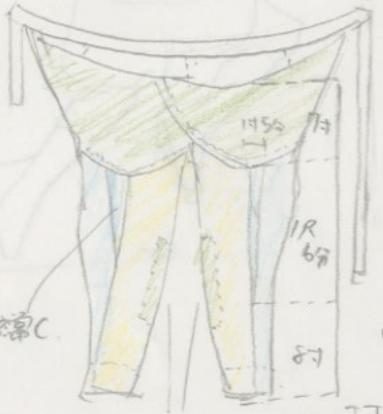

4分 4分 5分

樽A 樽B 樽C

膝当

3分 2分

樽C 9分

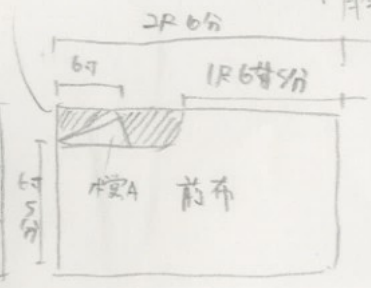

高機

此機は、1921年、A.P. 社の
改良 されたものである。

1500.

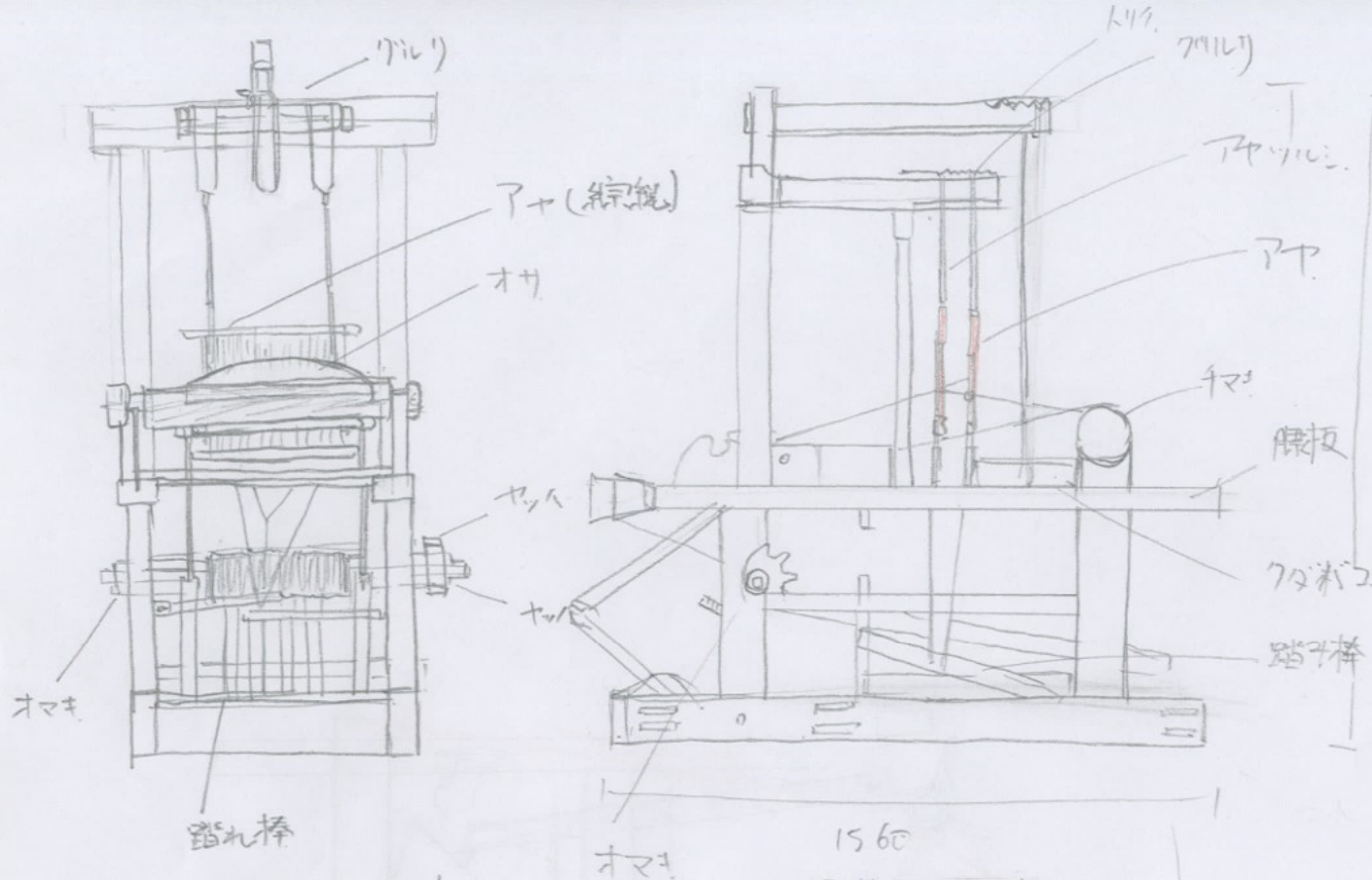

1560

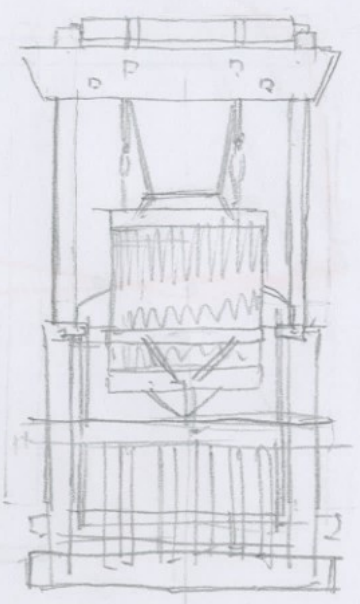

オヤ 270が300のとき

ハカヤの
な机
ハタオリ機と聞くとヤドリ 仮に
ある高機をイメージする。机をたか
でも高機より地機の方が好きだ
なんでかと思うと仮に高機はハイジ
ビホーくしていいのや!

地機

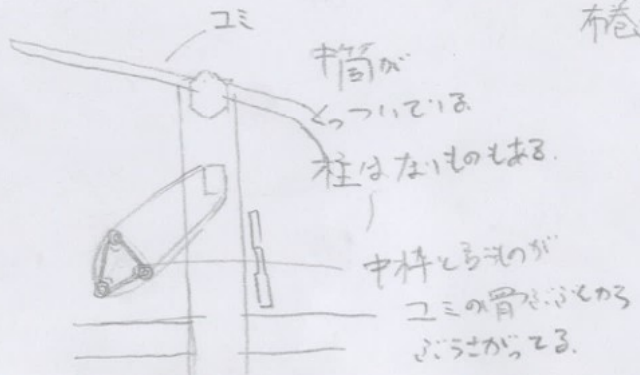
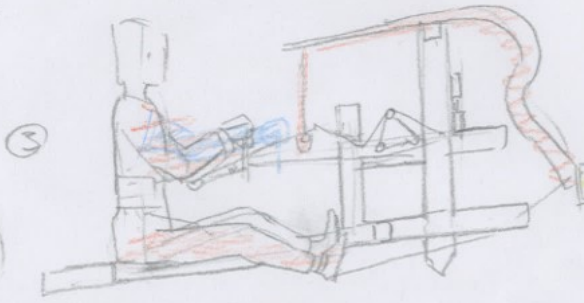
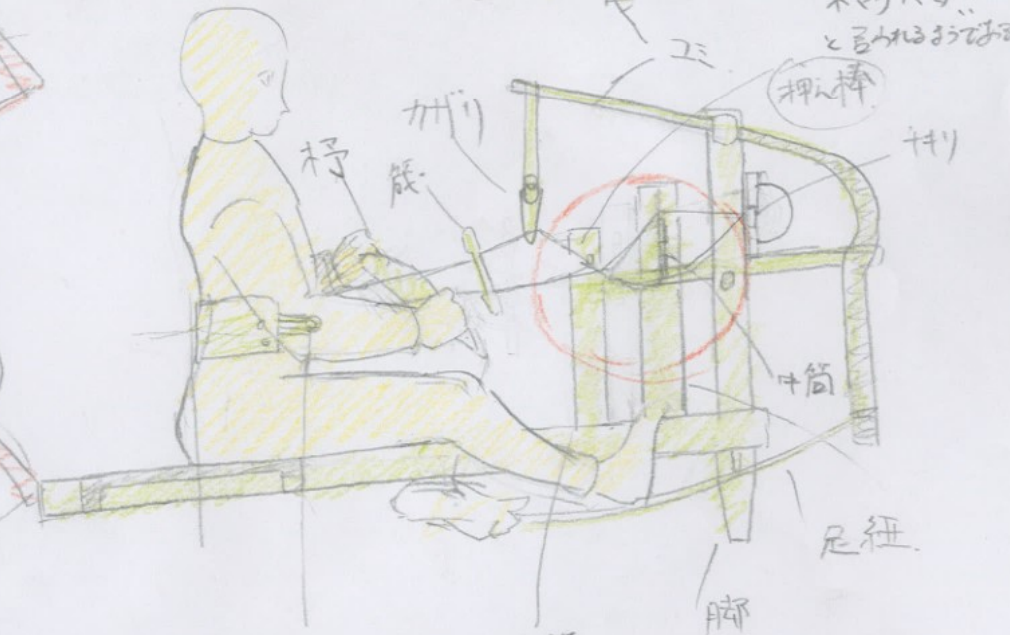
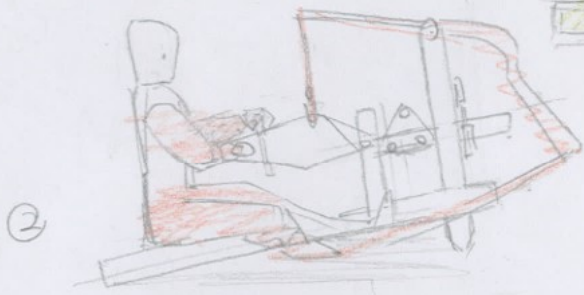
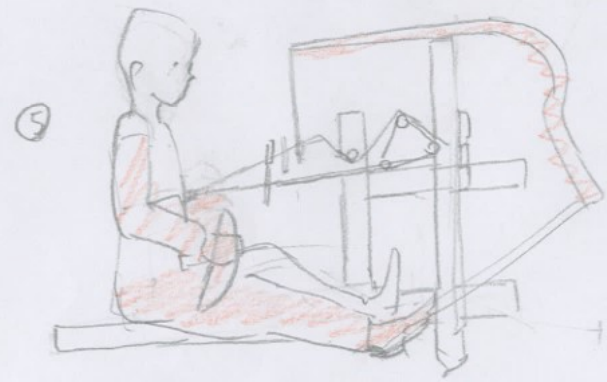
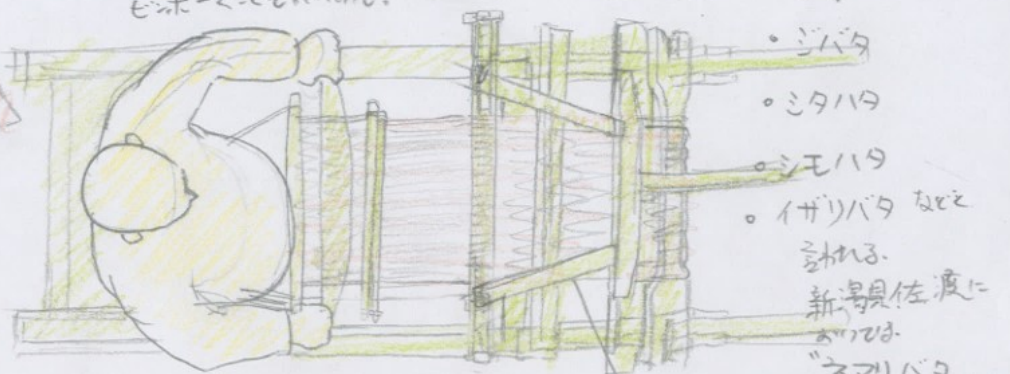
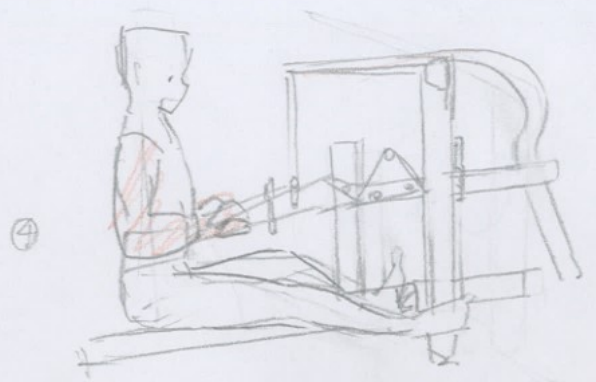

柄が考へた。ブルーと緑でぬいた
部分にだけかければいいと思う。
赤丸の部分は立体にすればいいか
と思う。(丸かためす) ので。

柄が
ついている
柱はないものもある。

中柄と柄の
コミの骨をぶつかる
ぶつかる。

糸車

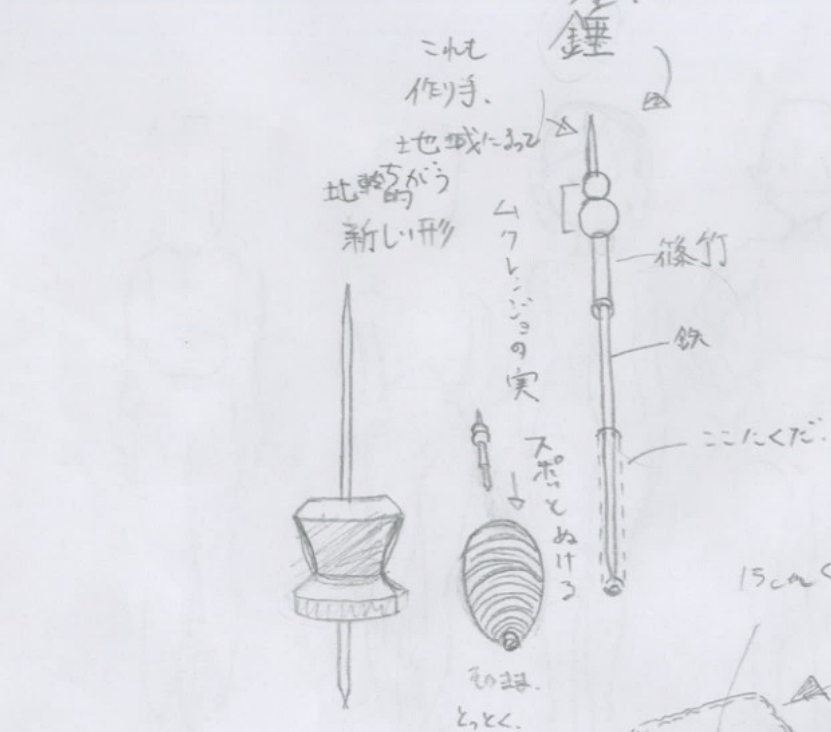

つぎ鐘

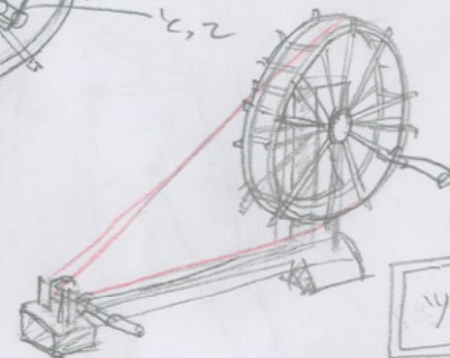
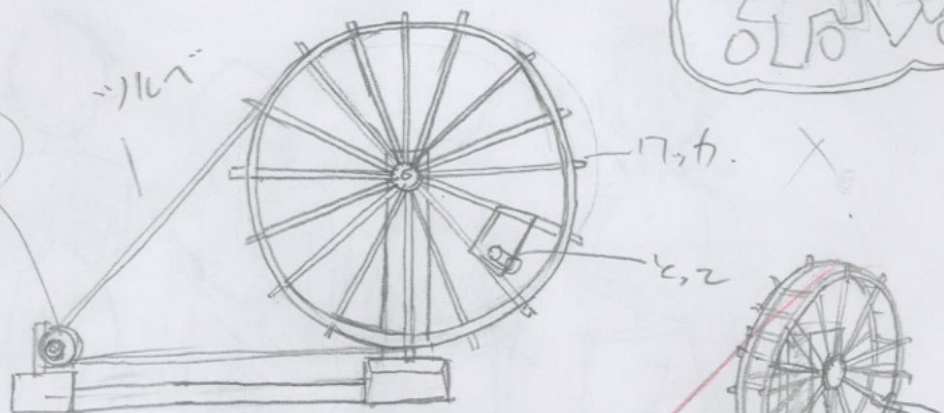

つぎ鐘の作り方

15cmくらい
1799 (木下) 北の新しい形に合わせる。つぎに合わせる。

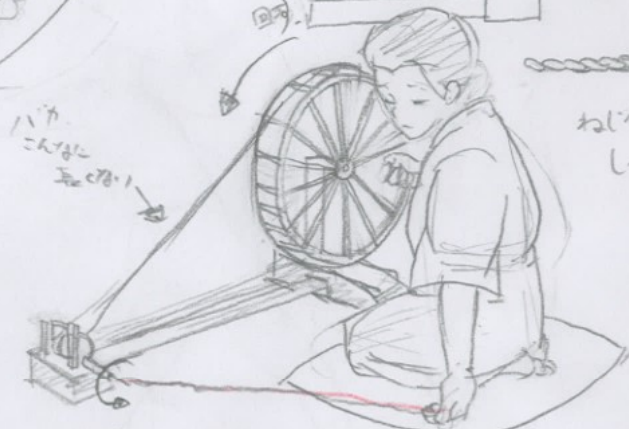
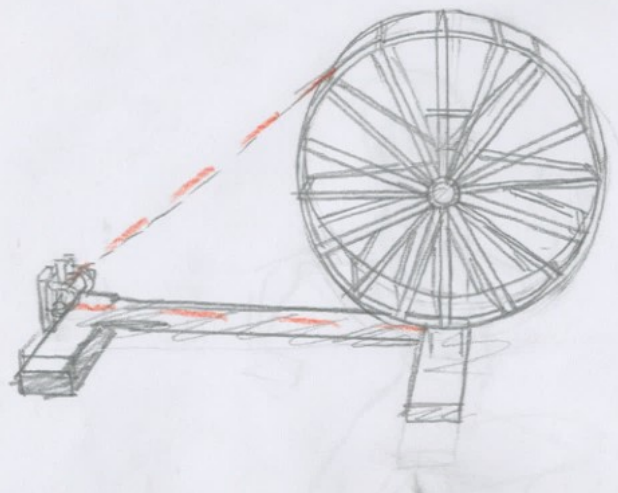
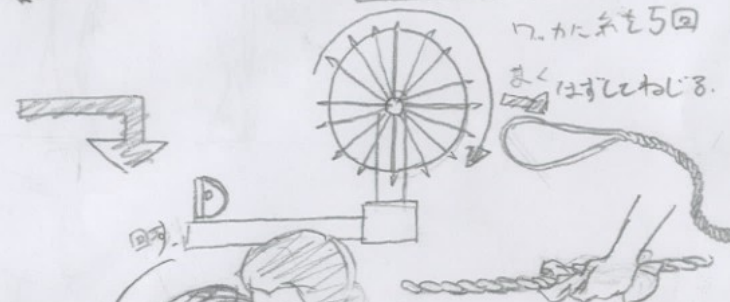
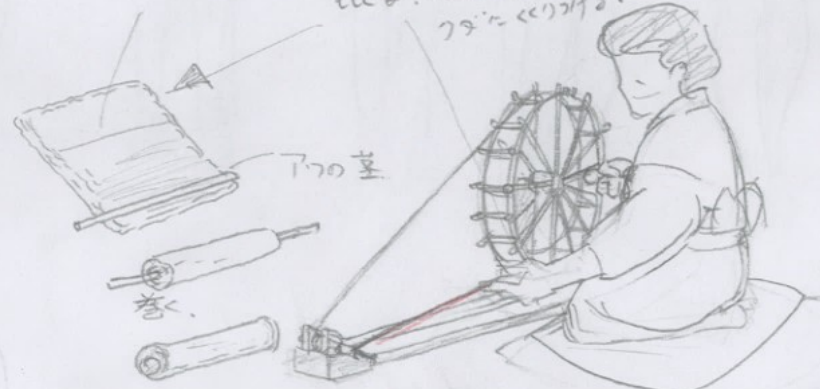

つぎに合わせる
つぎに合わせる

つぎに合わせる
つぎに合わせる

つぎに合わせる
つぎに合わせる

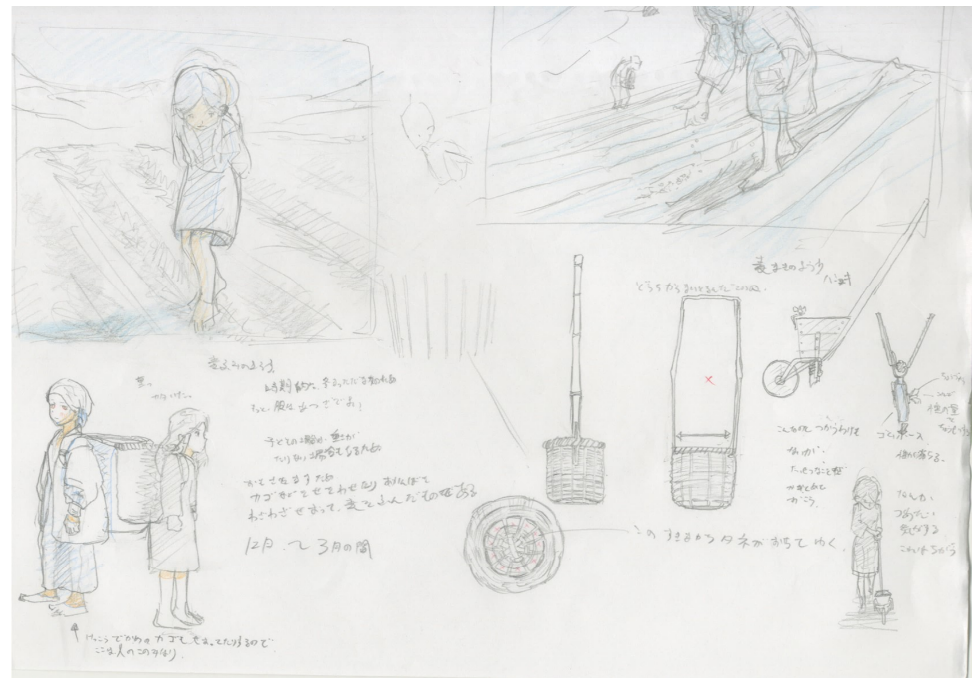
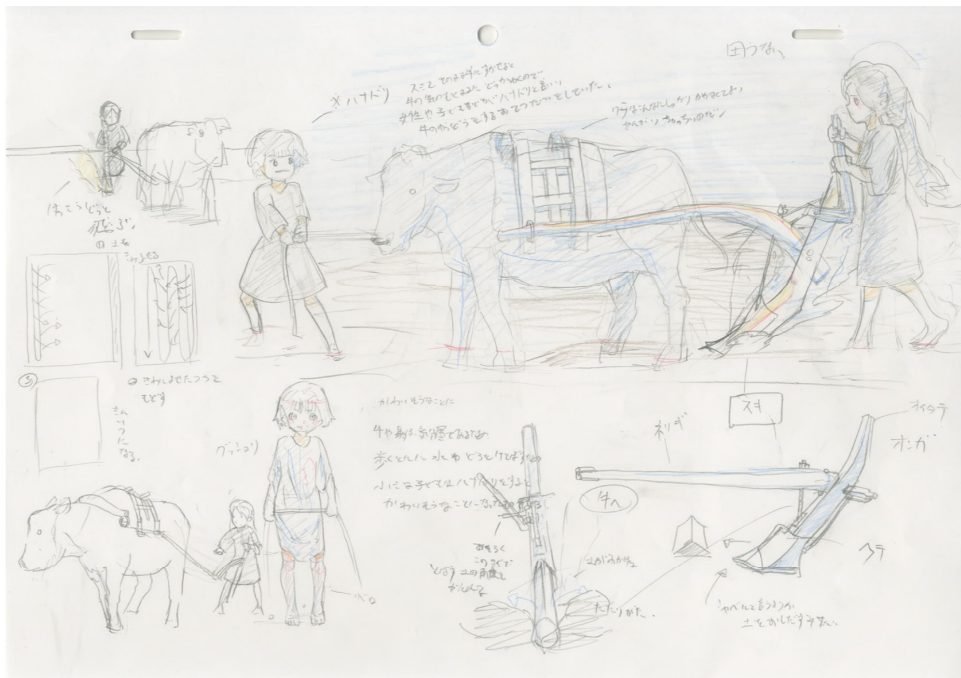
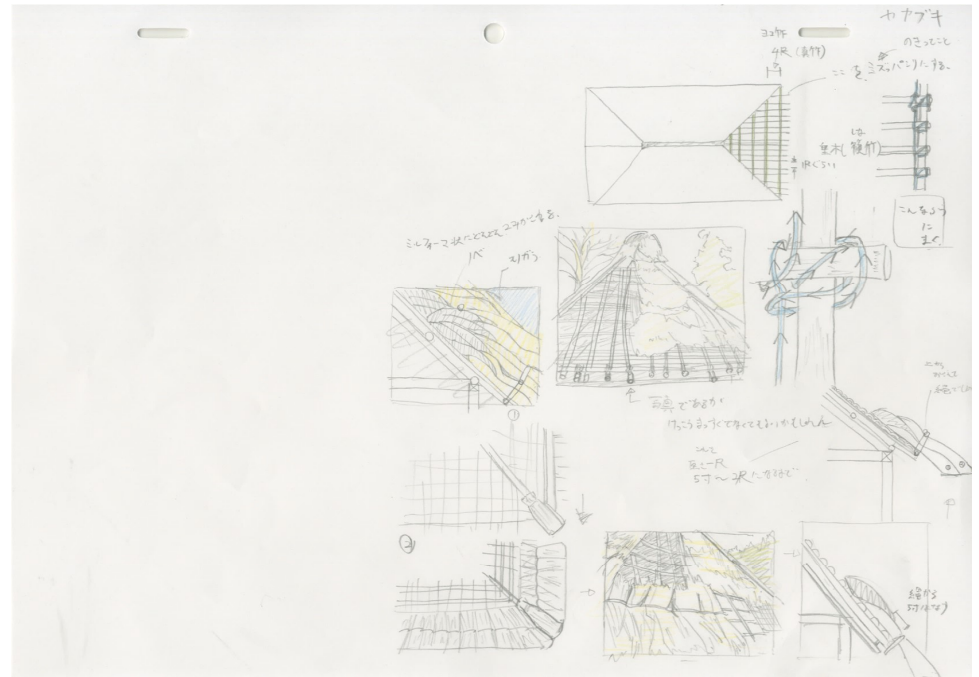
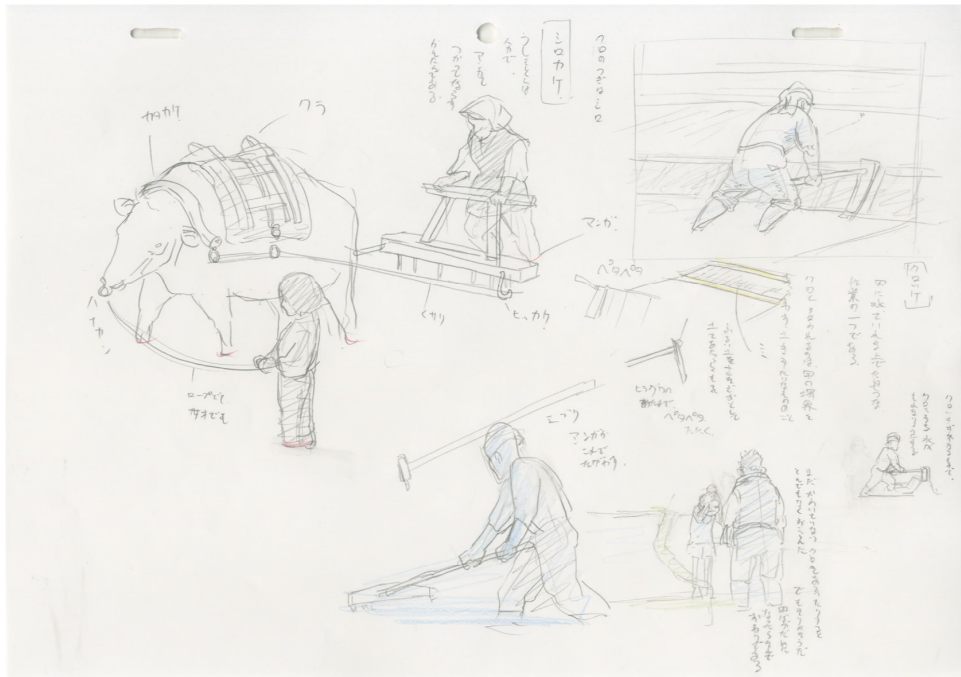

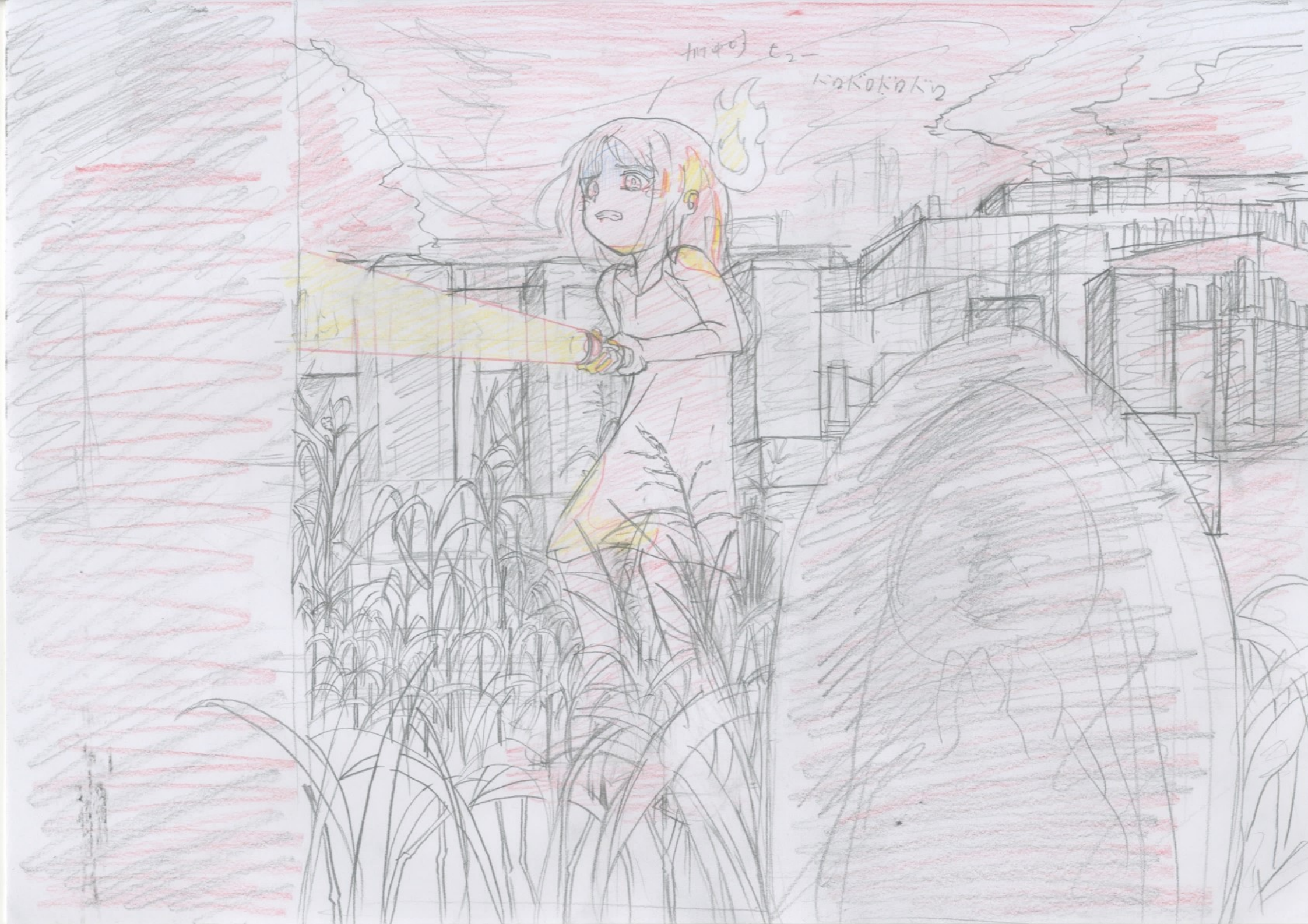

ついでに えー

kokorokoko

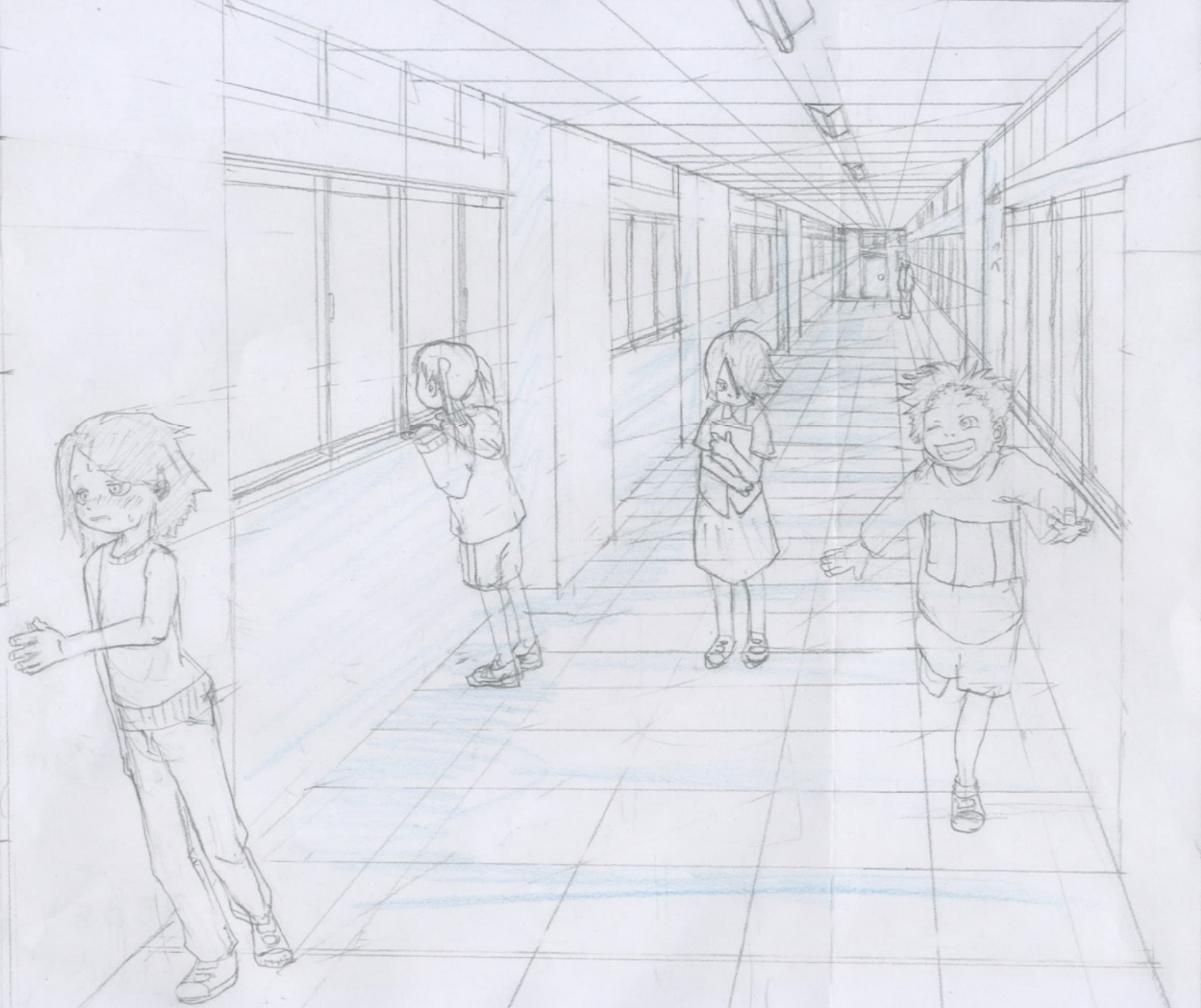

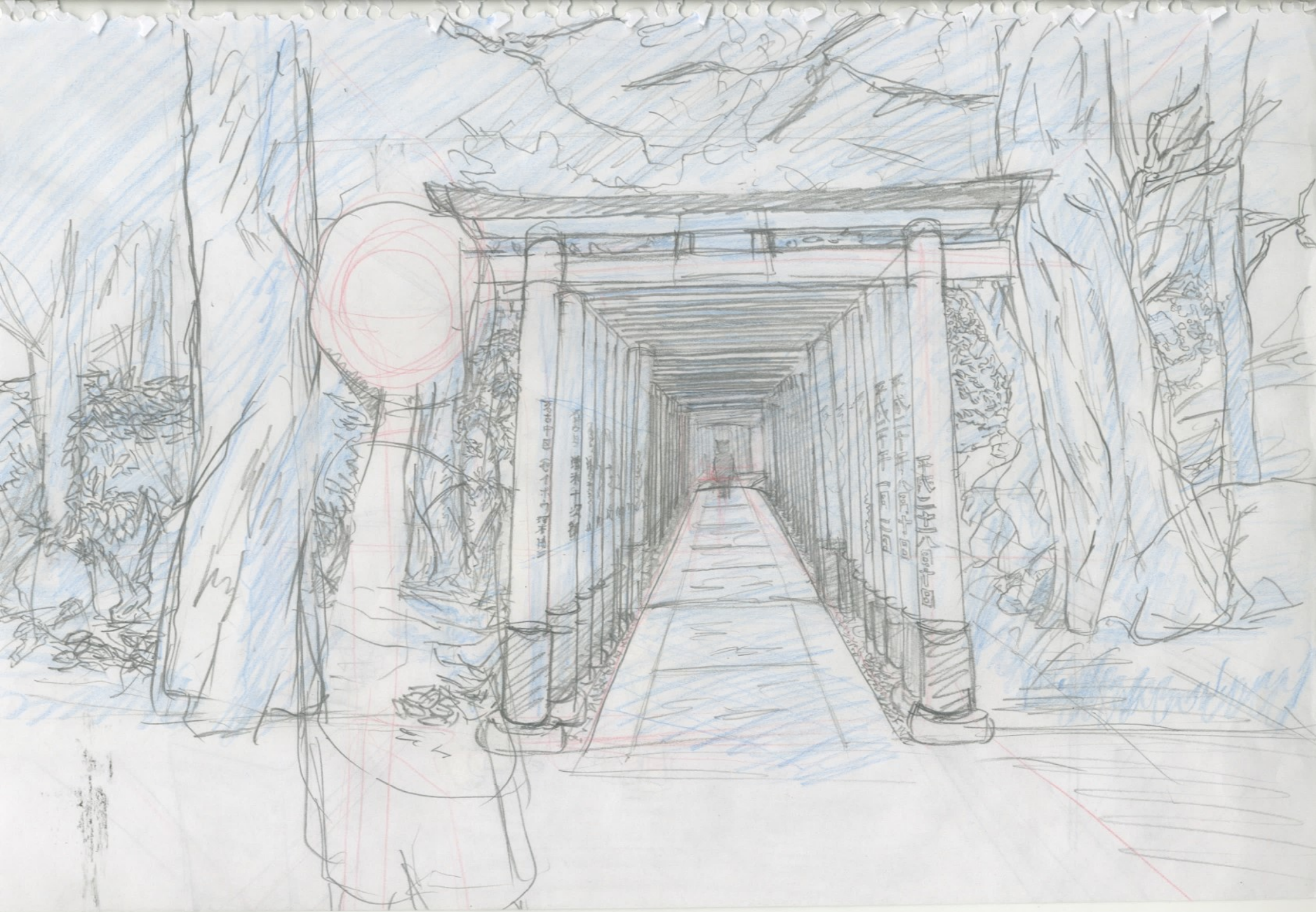

平溪二十四間
平溪二十四間
平溪二十四間

平溪二十四間
平溪二十四間
平溪二十四間

24756

37.



音のあそび手あそびの少女

9 さいくさい

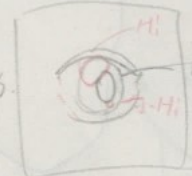
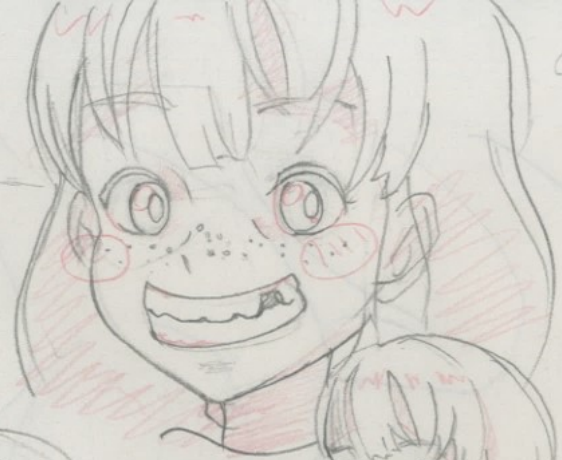

あそび手あそび
zzzzz

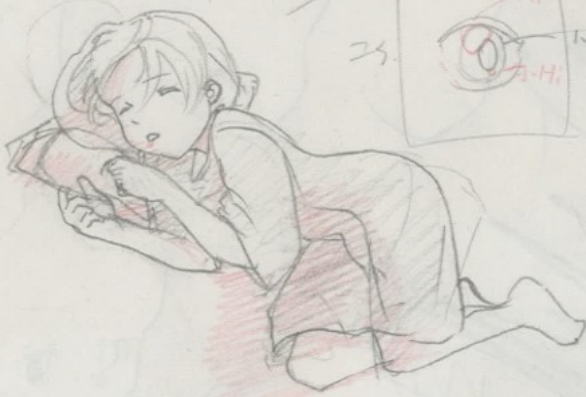

そとで遊ぶこどもたちをよびよる

それはかすかすとした音が
たたくはらたたくはら

少女

9.9c

ボーンズ さん 1.3.9.

M2 重機 12.7

327 (45mm)

7.62mm

ノロタン

水銀弾

さか
Pistol

質量がバカ重なる
20mm エネルギー
水銀の密度がバカ高い

タカستن 重機

客化ウラン

...

カーリグスタッフ
ラマテ

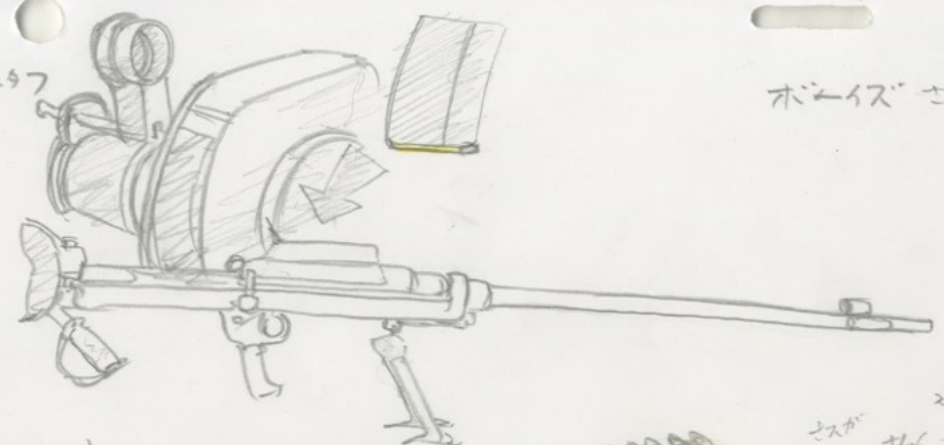

スポール

後輪がら

500kg 以下の車
7.62mm 20mm 射撃

この銃はマガジンを
ねじこむの?

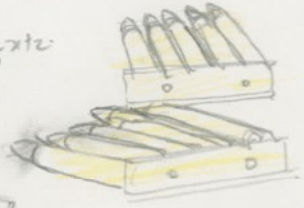

マガジンを
ねじこむ

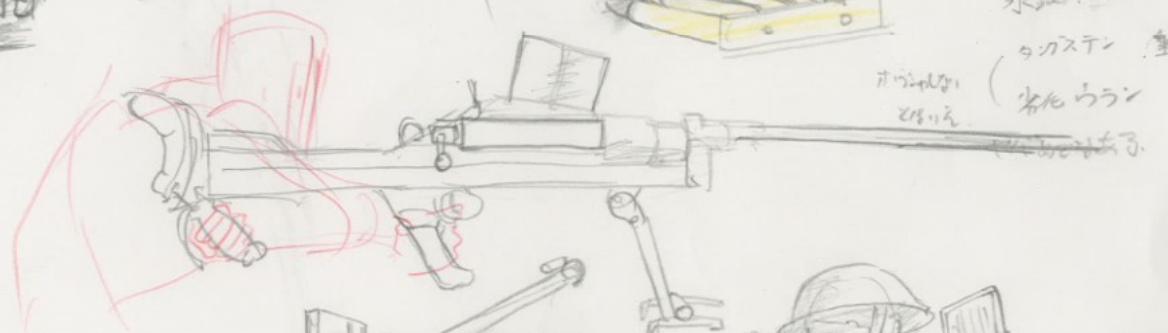

20mm 銃が
そのサイズの
70mm スプリング
70mm 銃が
ある

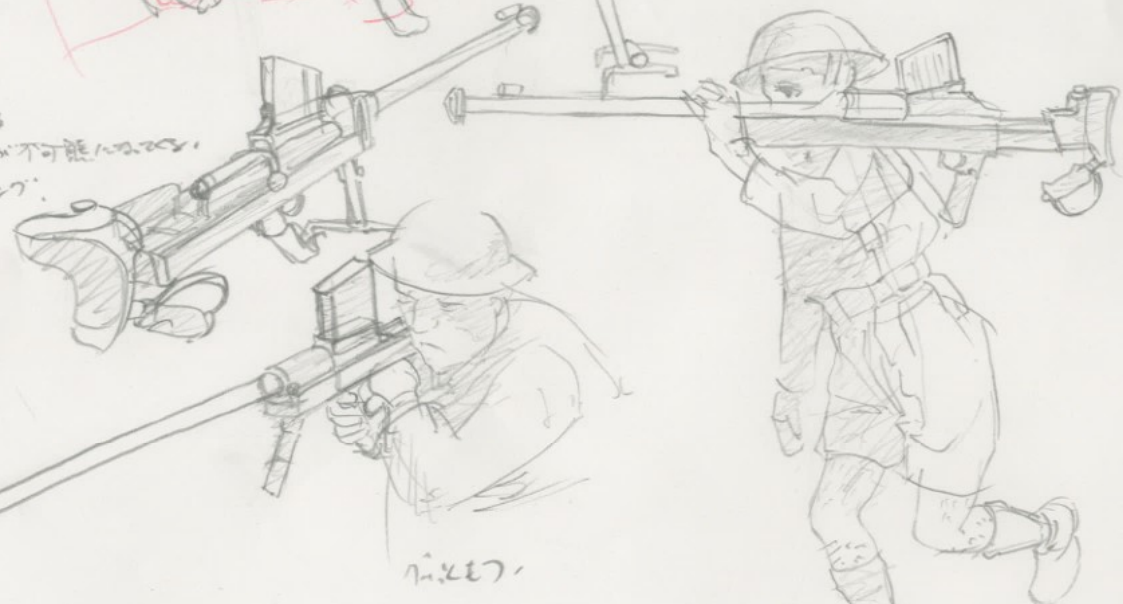

12.7

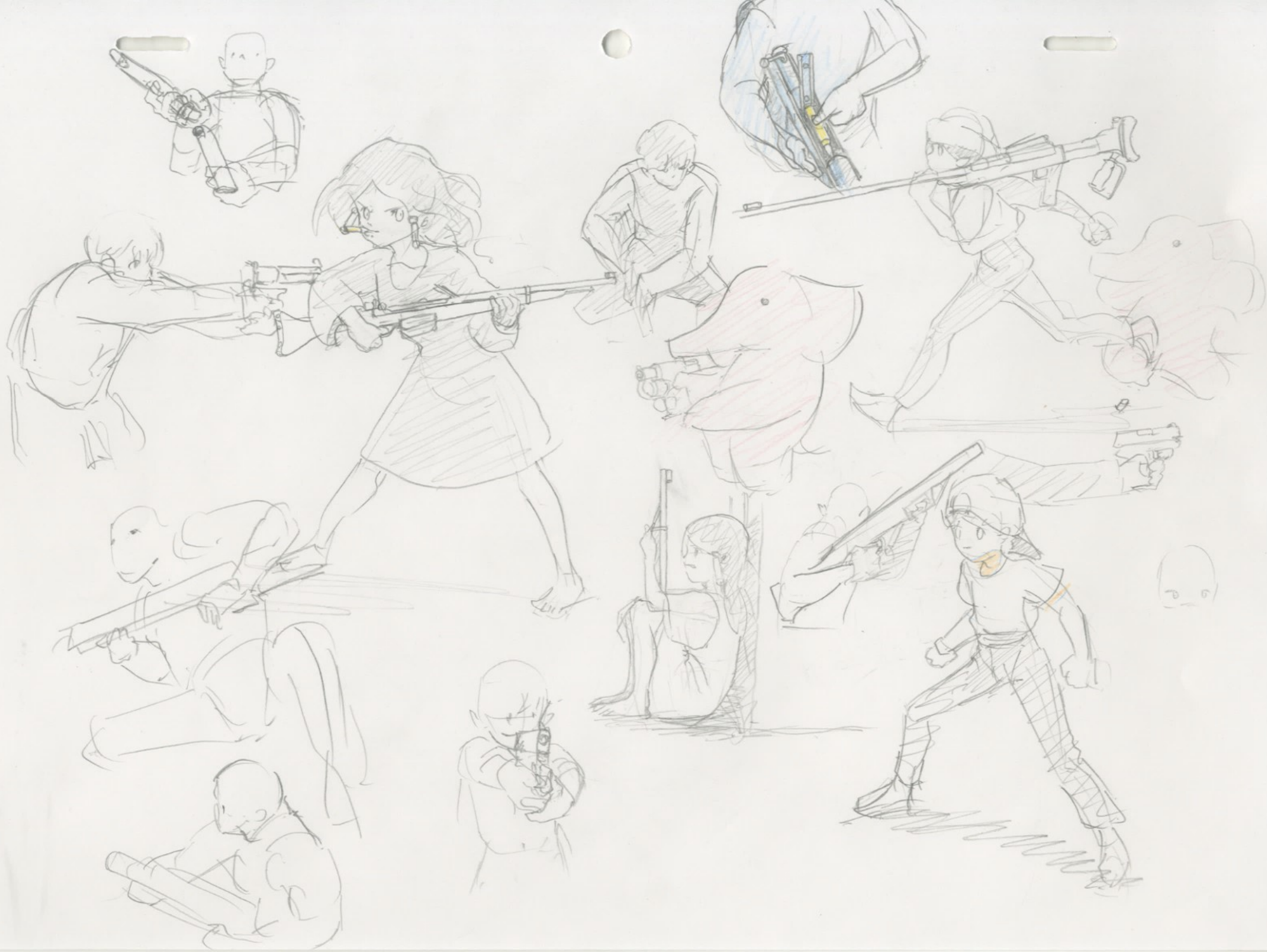

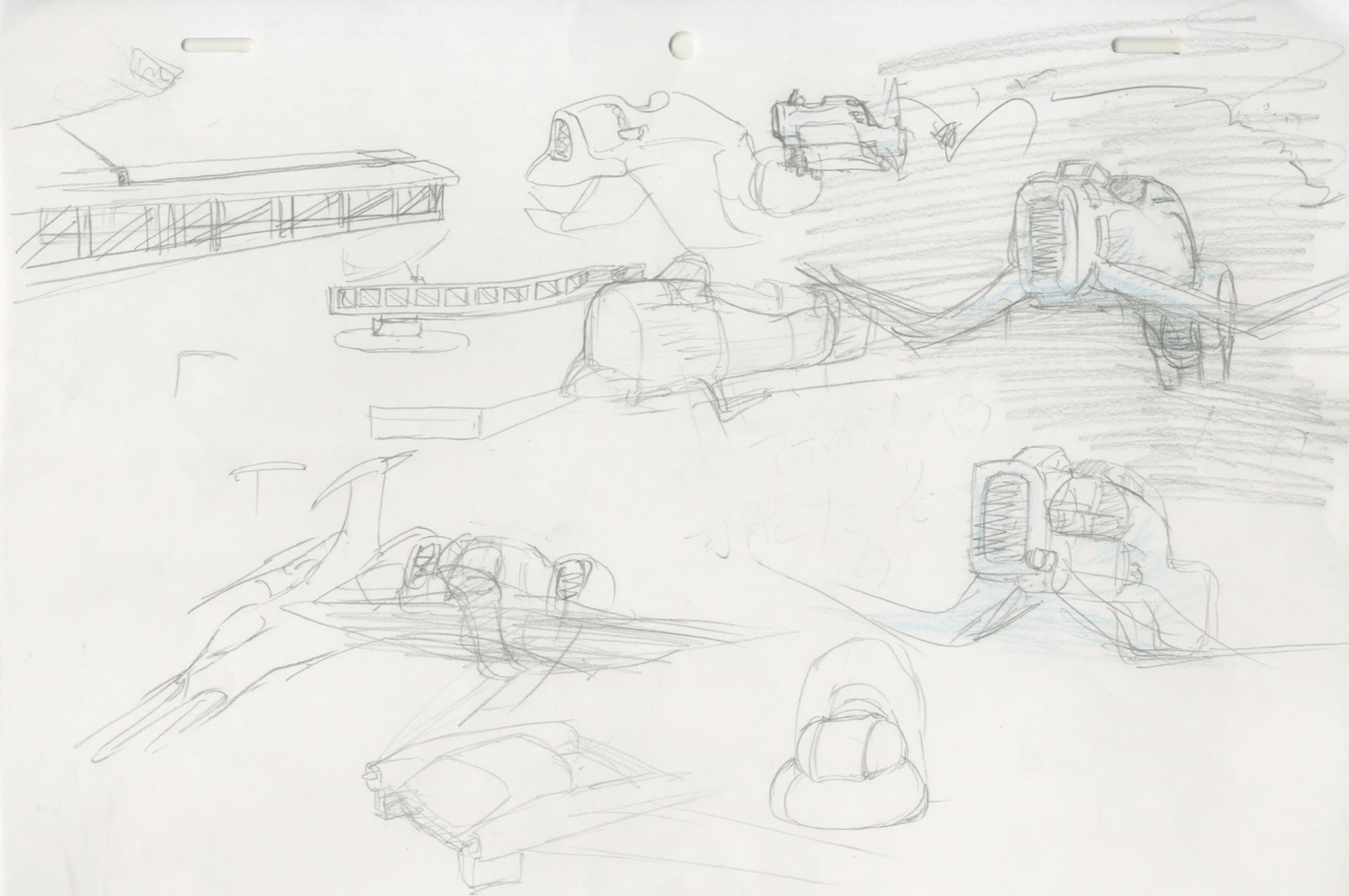

RPII

H.K
P11.

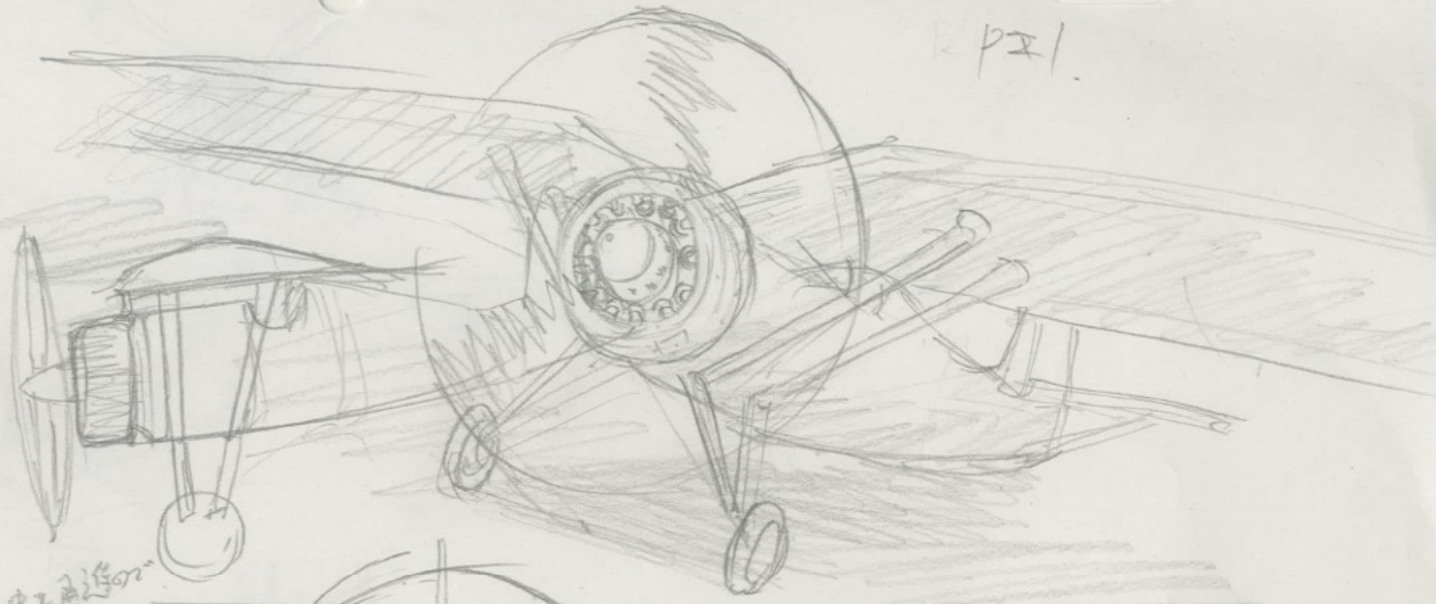
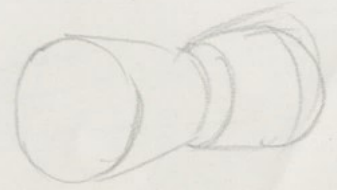

二つ
三つ
四つ

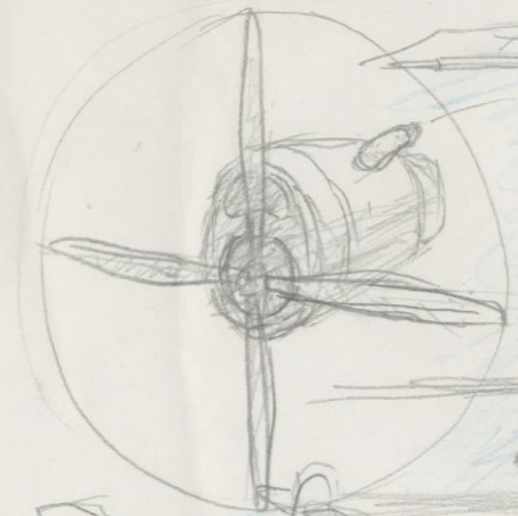

?

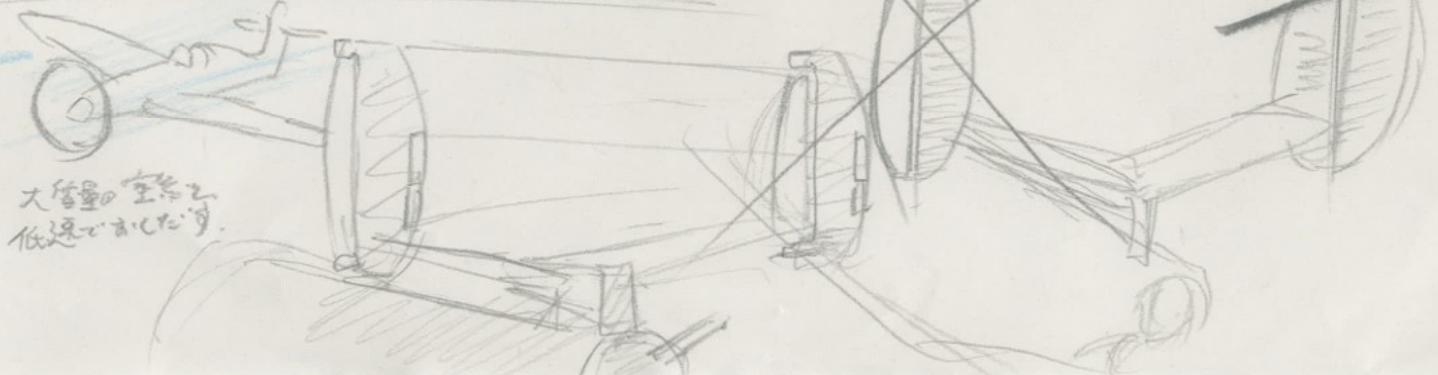
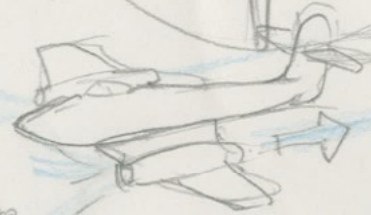
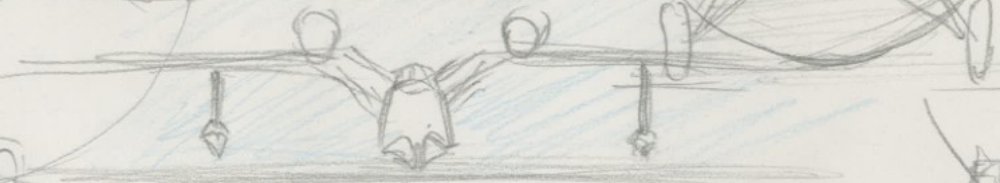
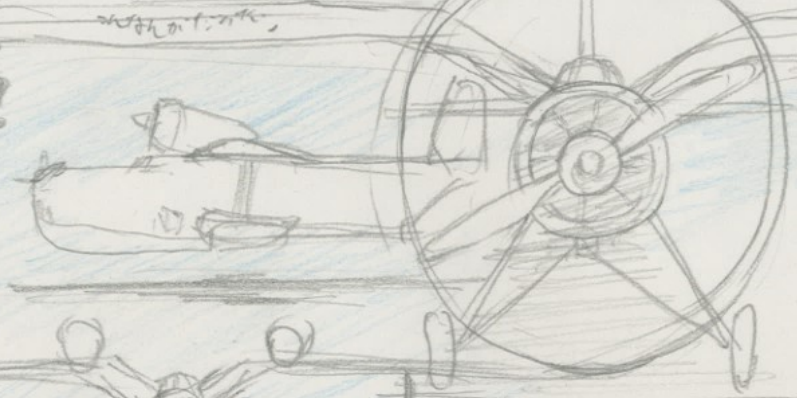

小翼
△ 高速で飛行

大量の空気を
低速で吸い出す。

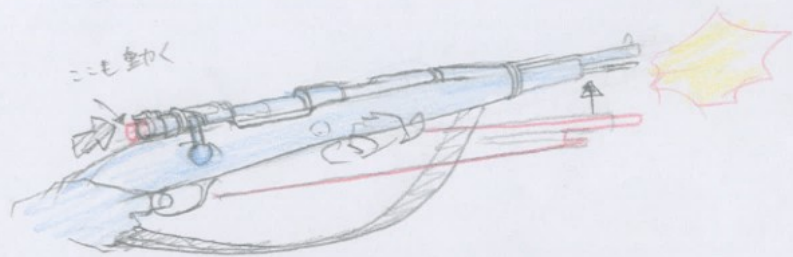

1849

kar 98k

マウナー

M14

M6A2

34.

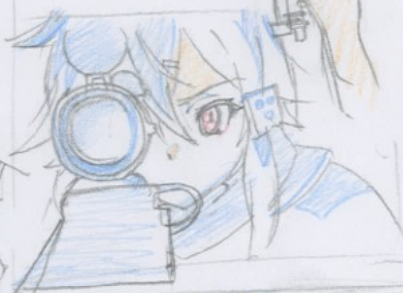
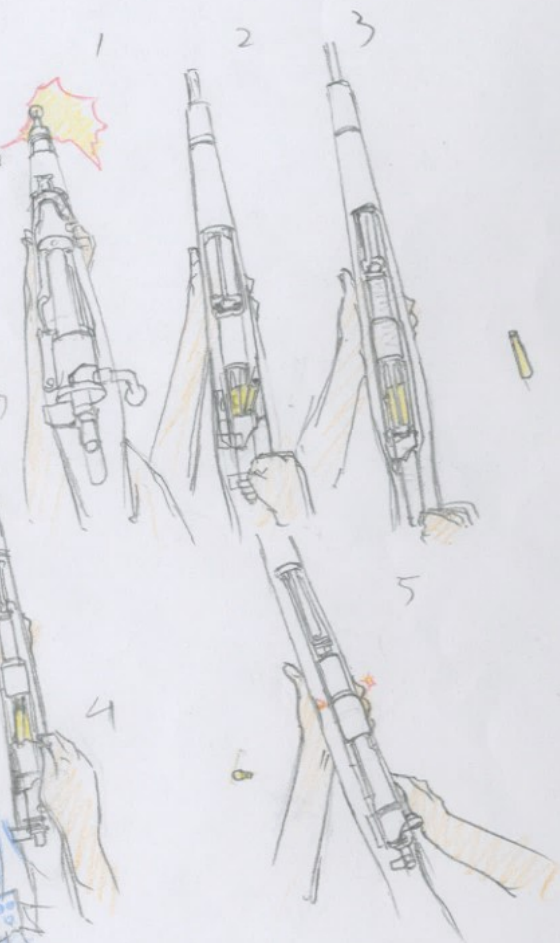

狙撃の
この演出対



あつた
1977年!

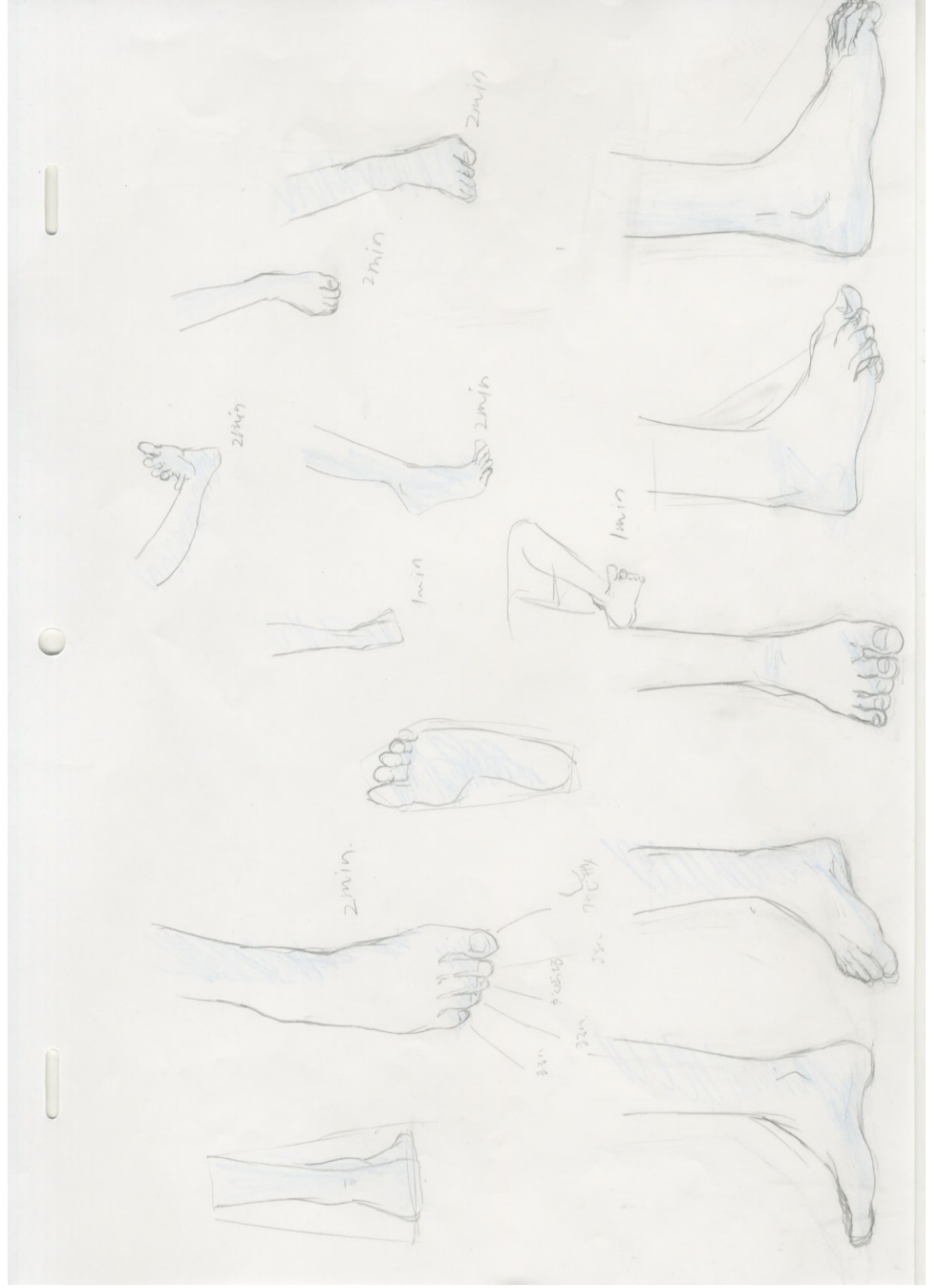



1. 10/25/98
2. 11/10/98

このデザインが
いいから
いっしょに
描いて

このデザイン
リストアップ
する

ホントに
みんなが
描いて
くれた
お礼

h

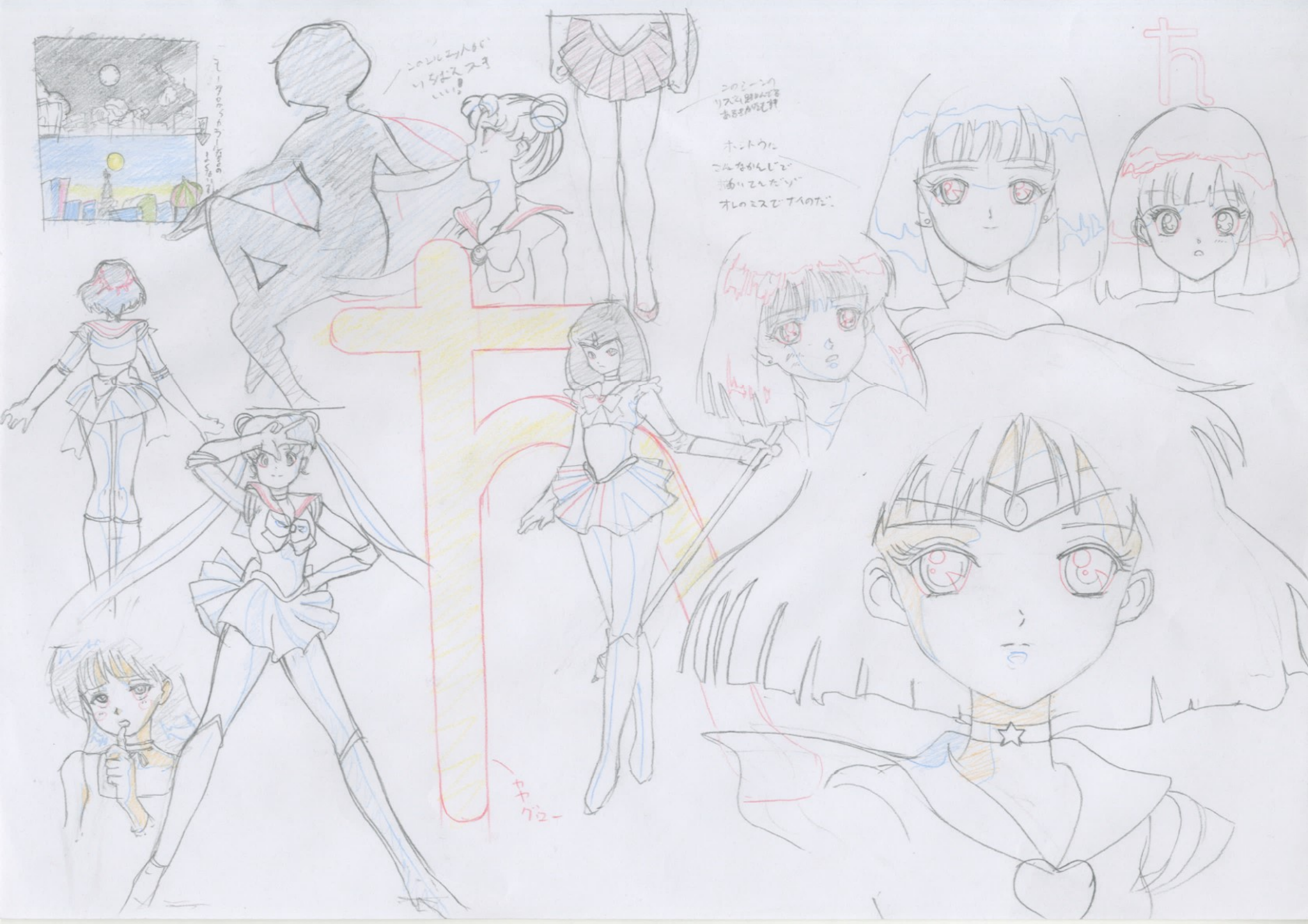

7/2-

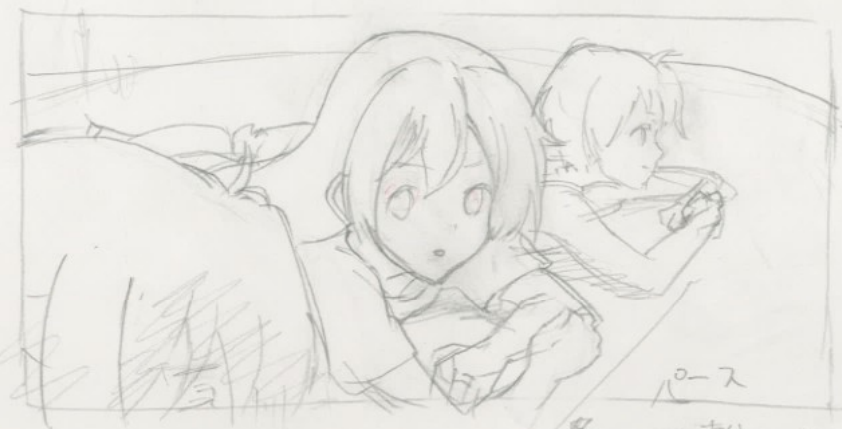
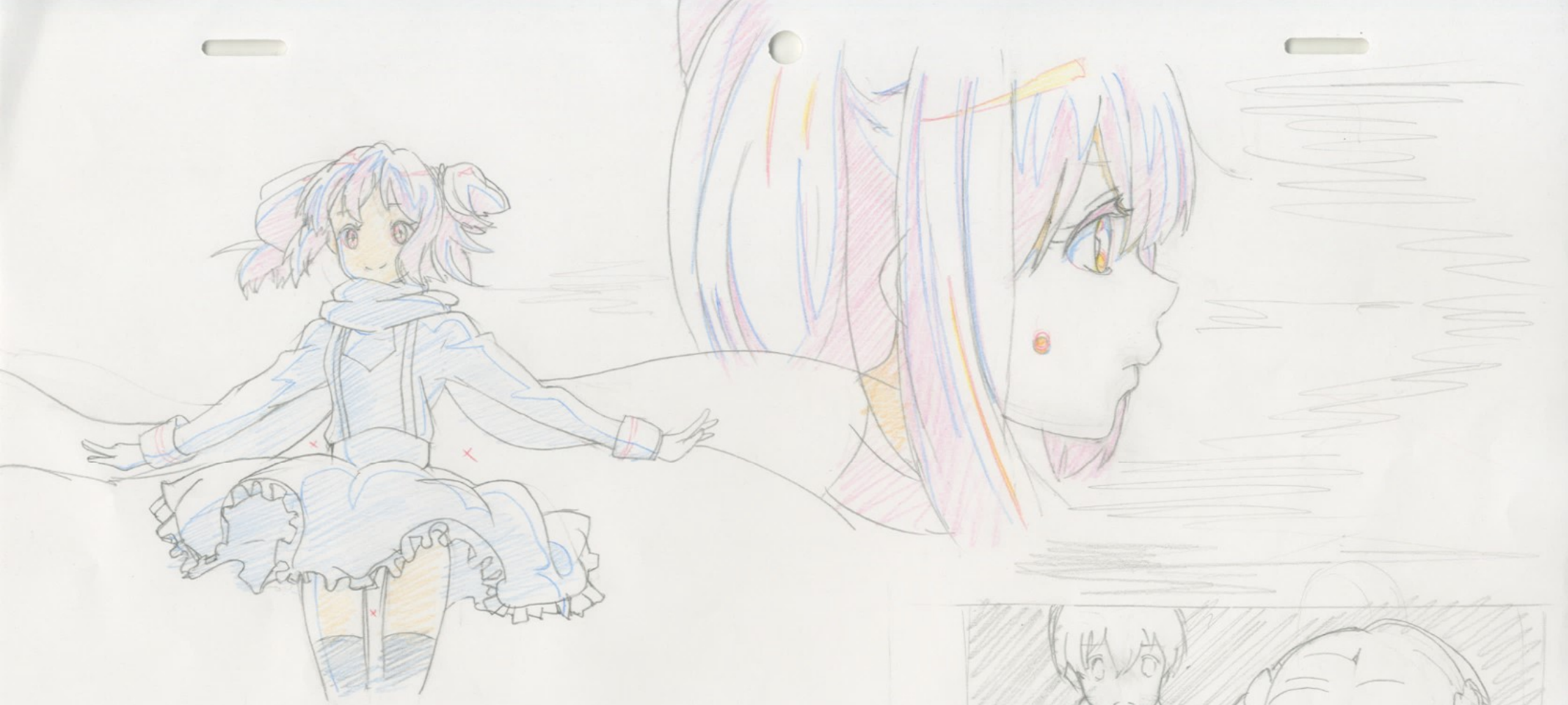

ポーズ
 → 空間感...だね。

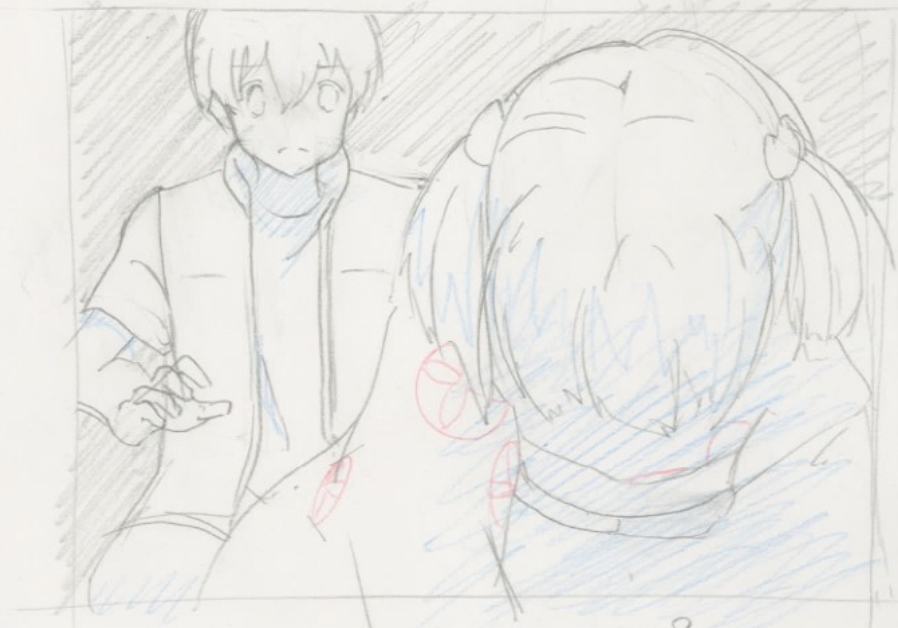

ポーズじゃないのか？
 平面にならざるを得ない

毛印:

オリジナル
ポーズ
スチル
服の参考



ニッパ



オリジナル
服の参考



オリジナル
服の参考

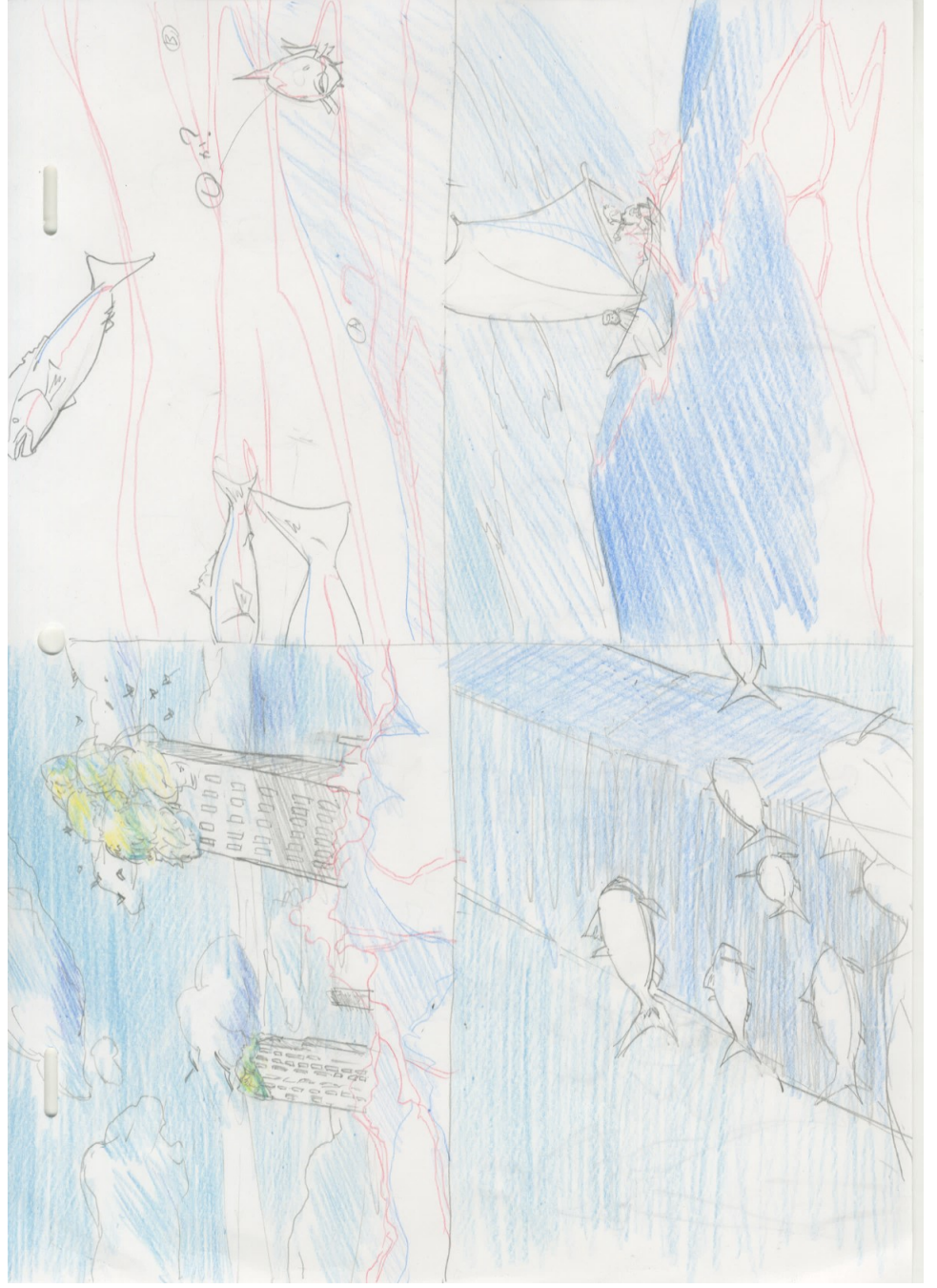
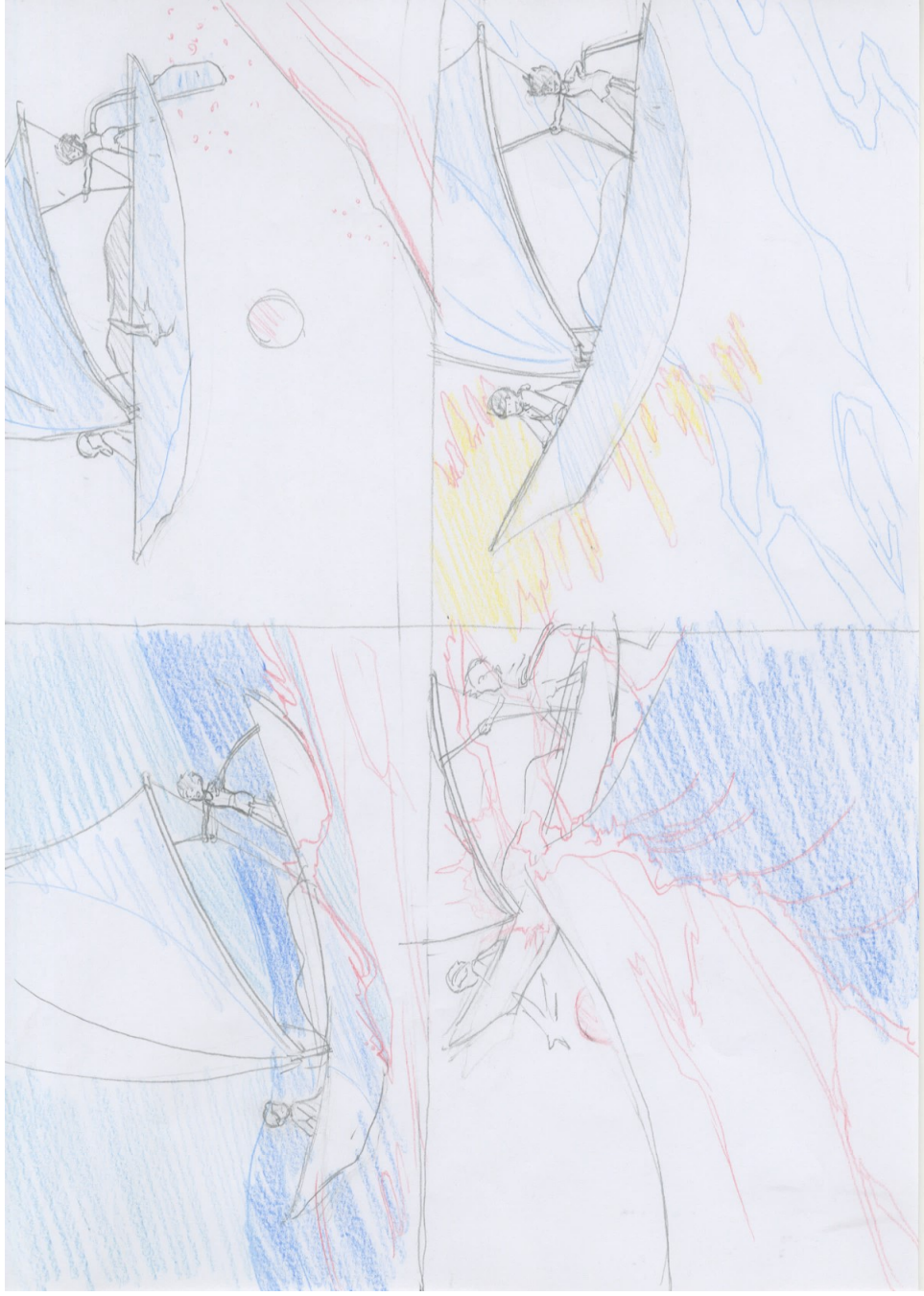

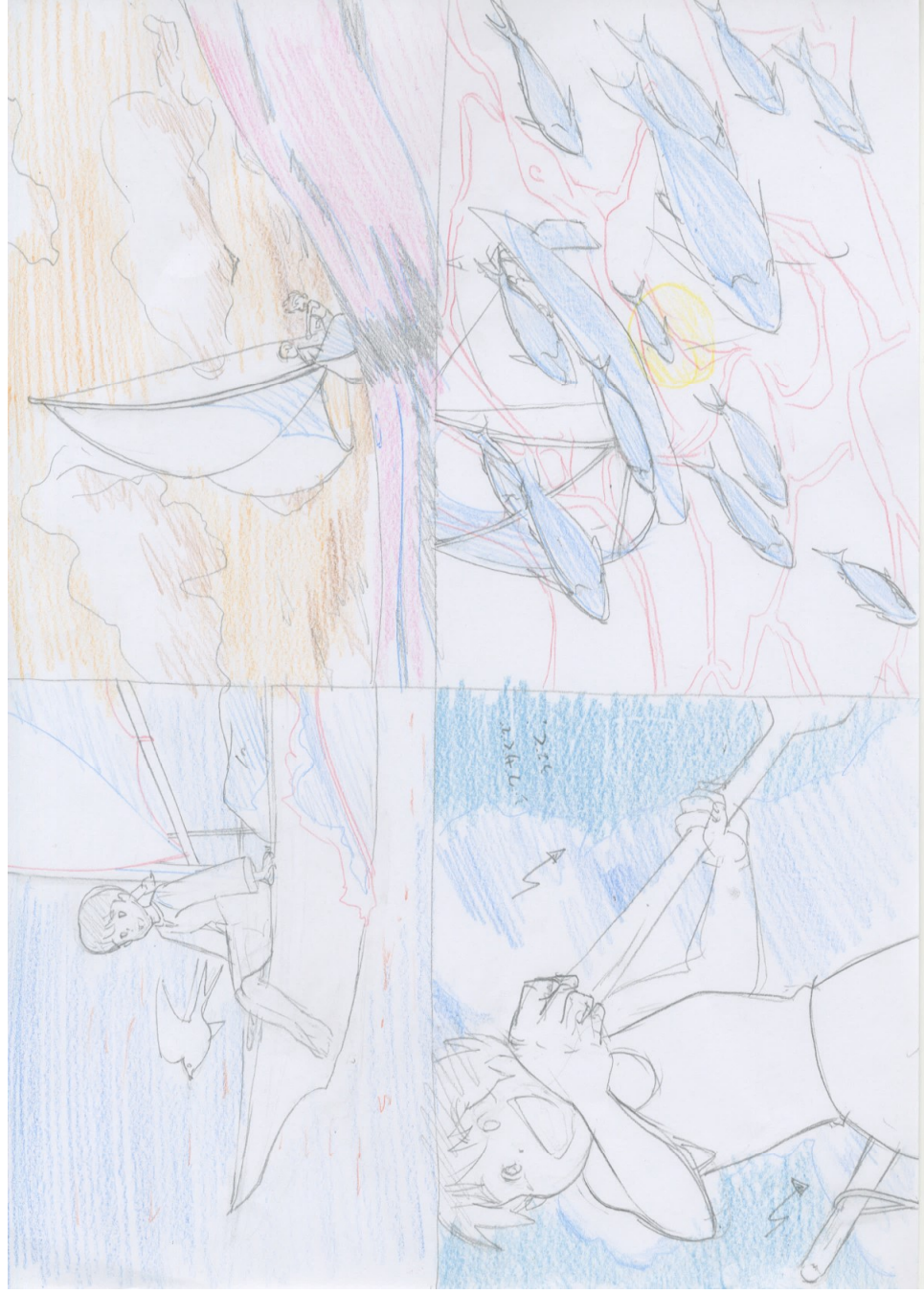

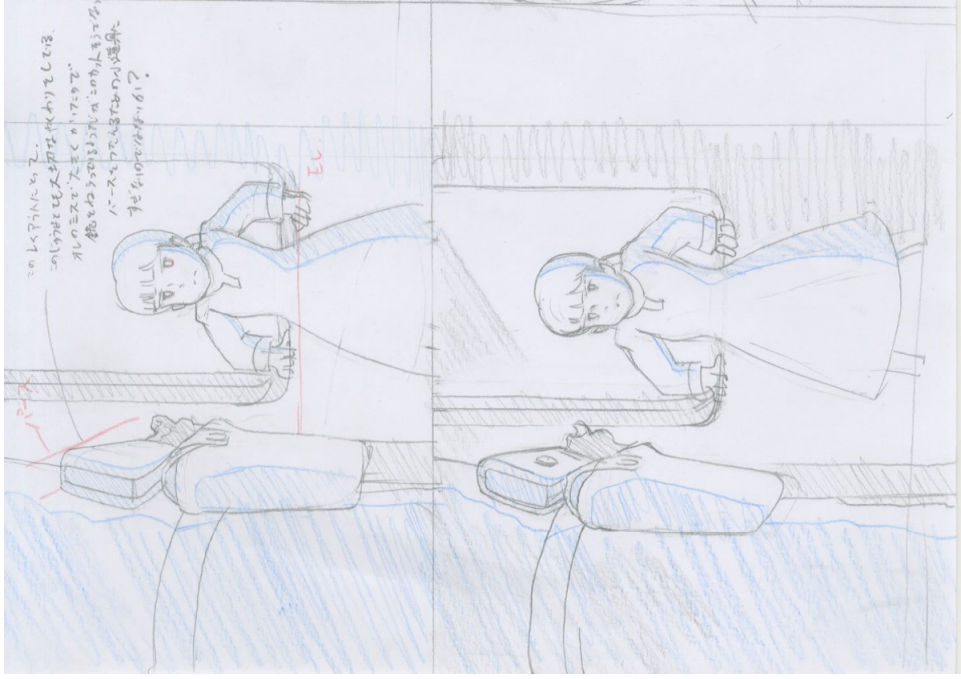
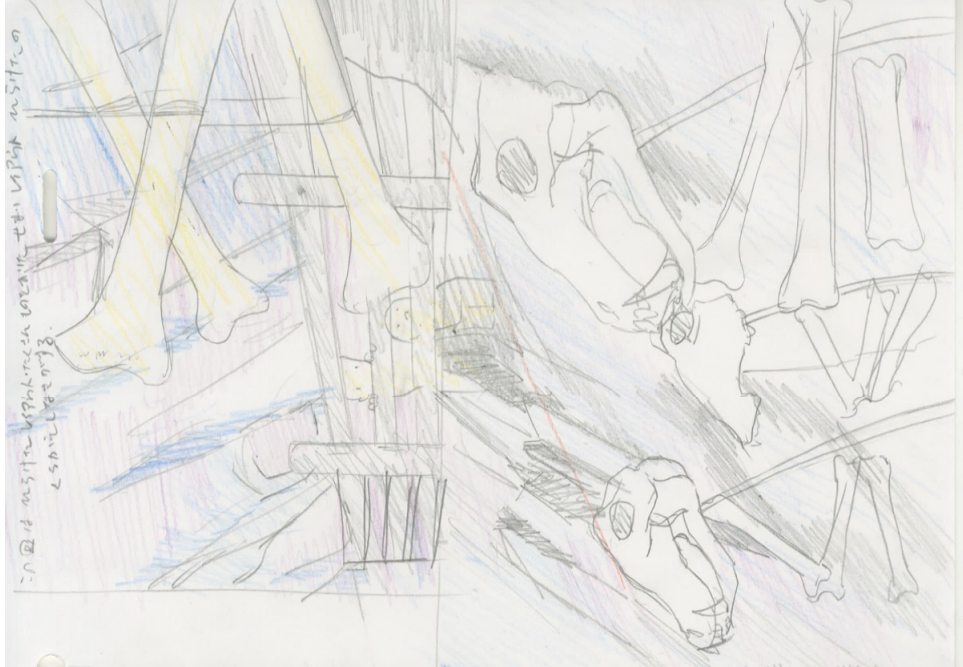
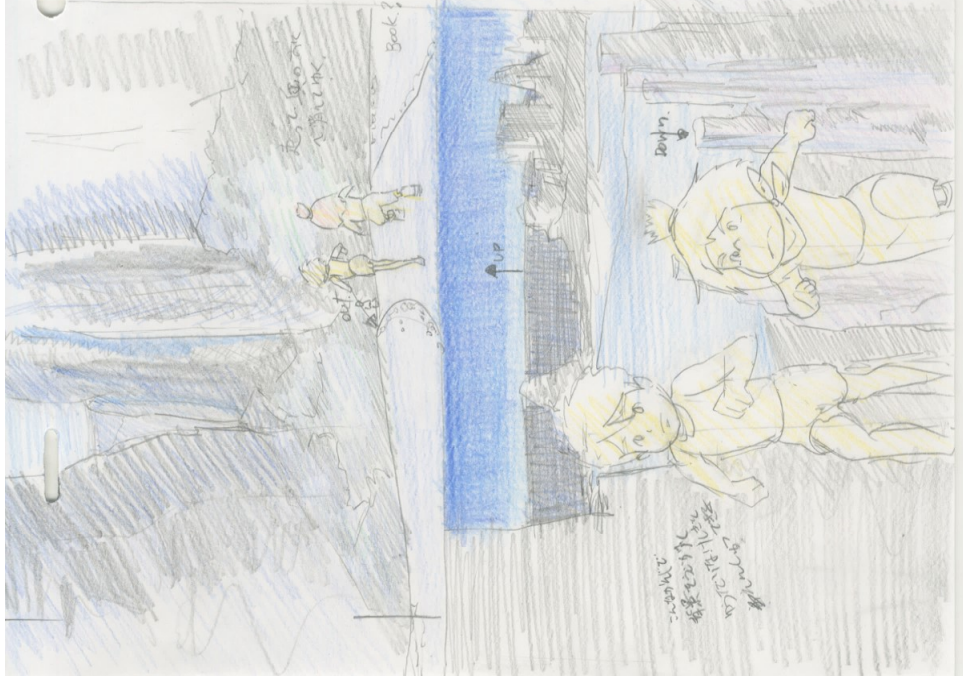

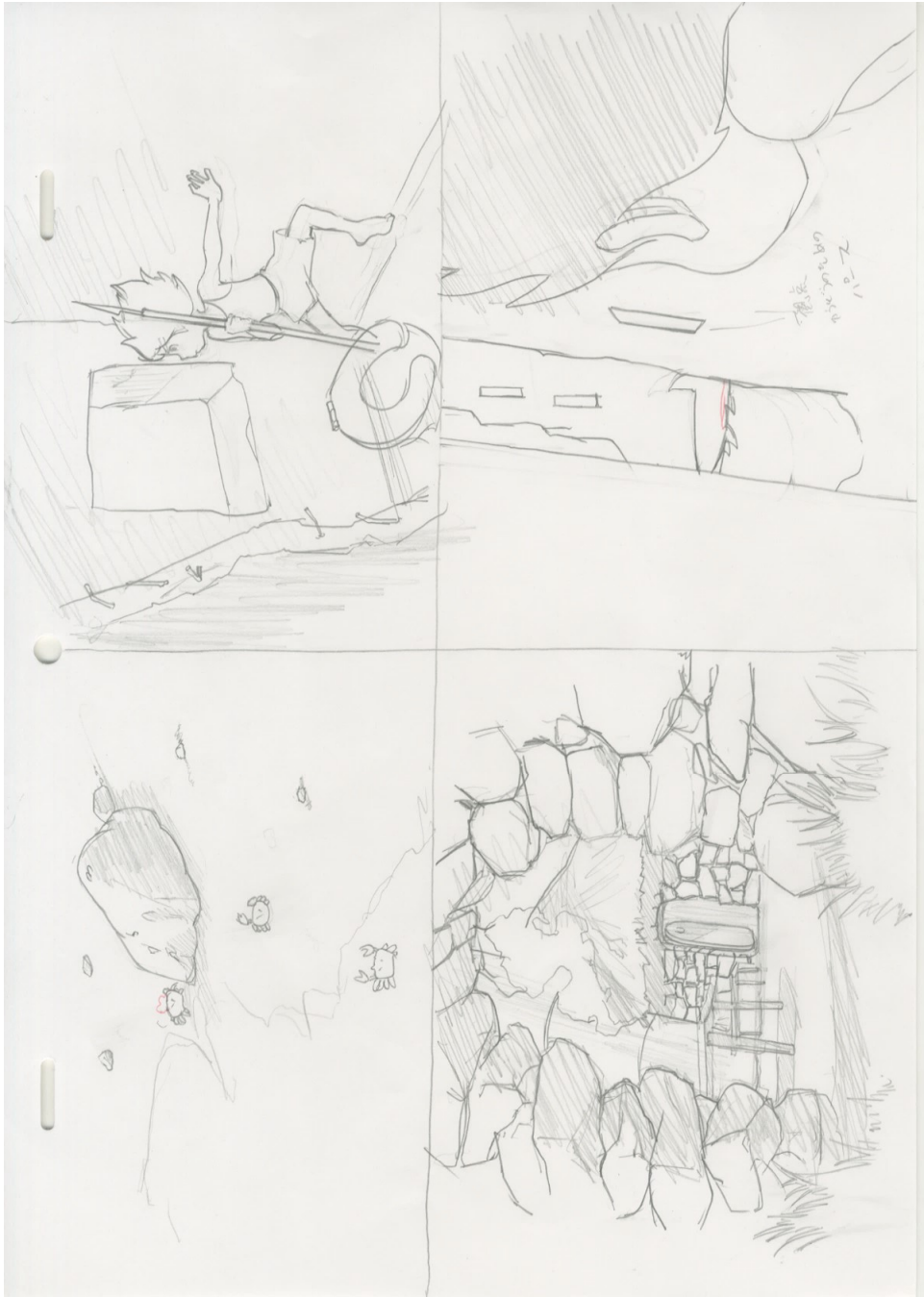
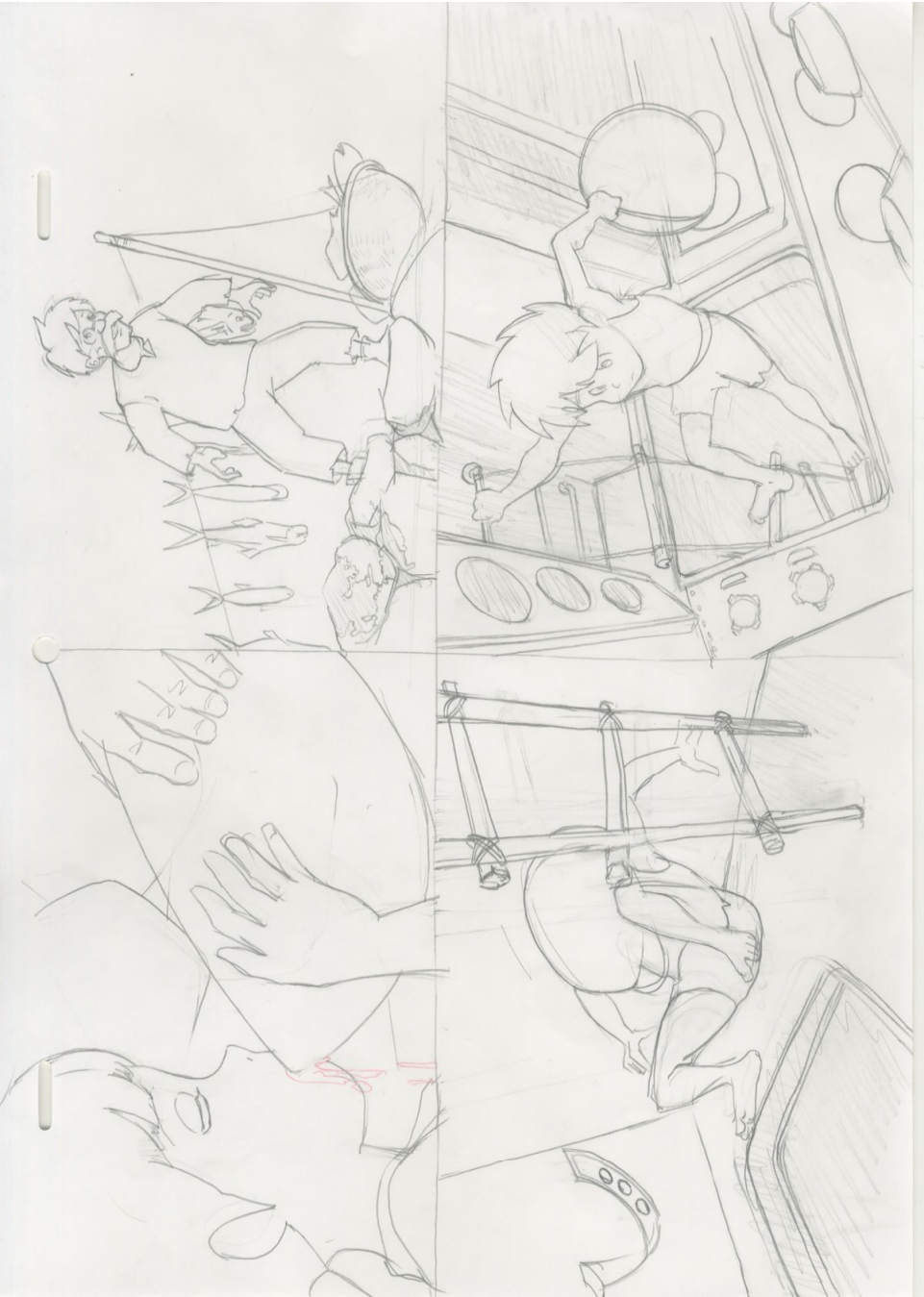

タホセin.

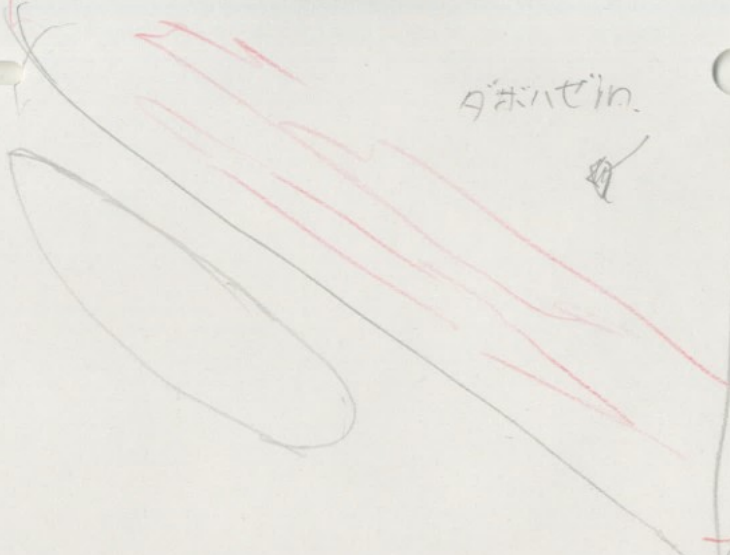

♪ 時代の風

この映画のシーン

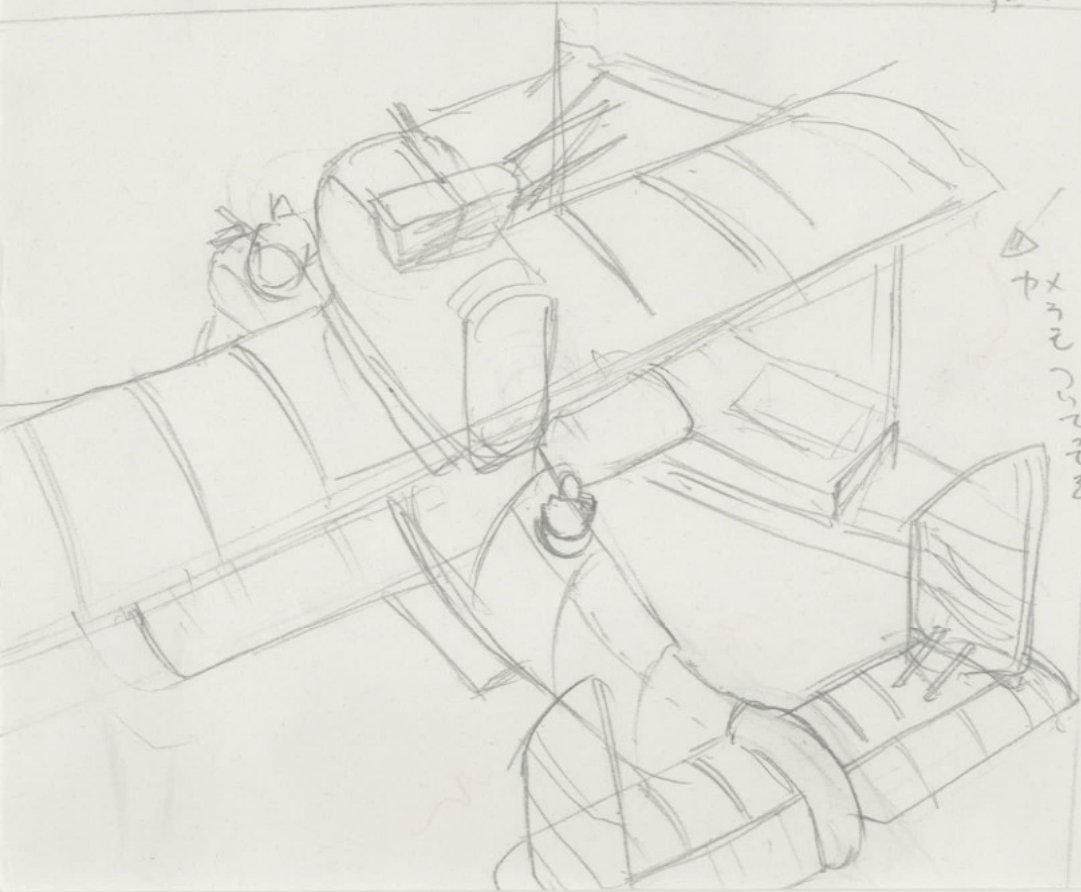

カメラの仕組み

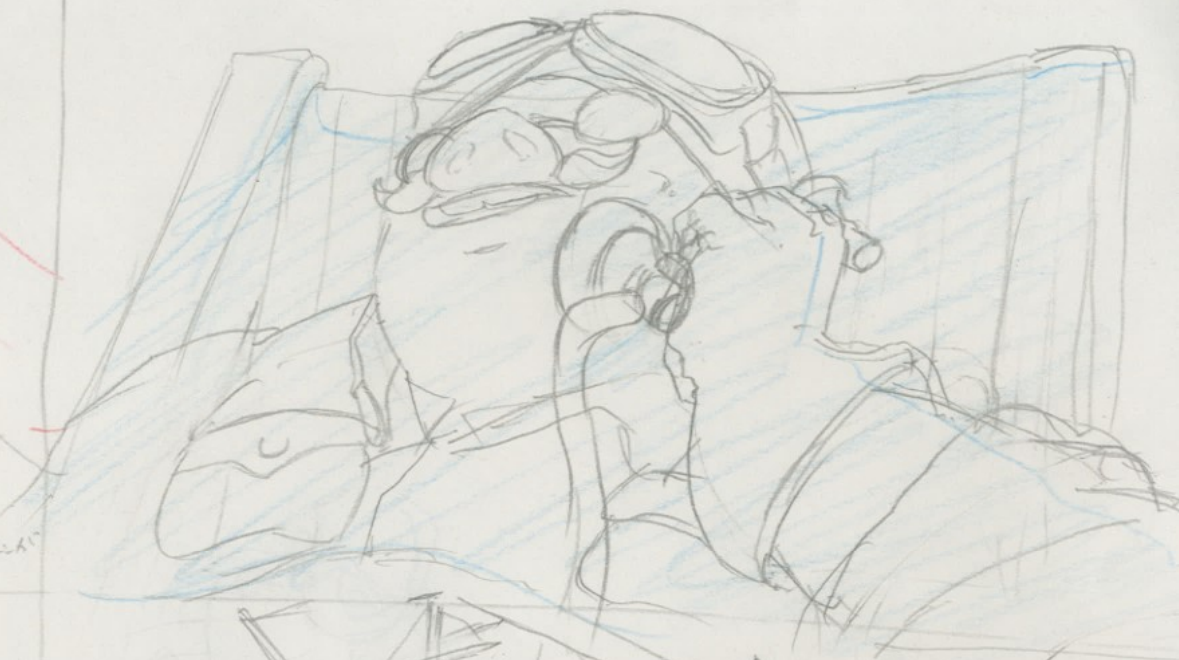

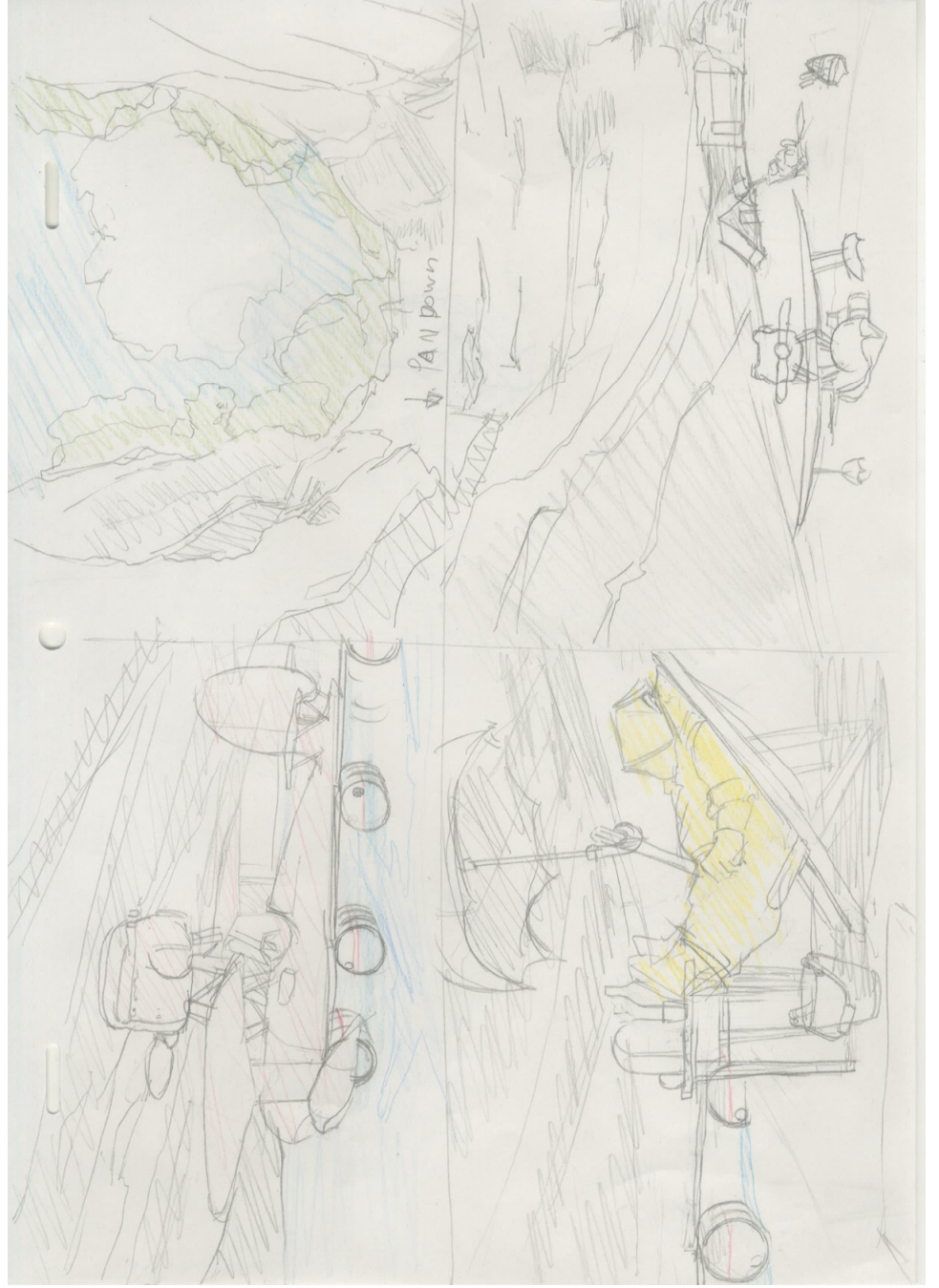
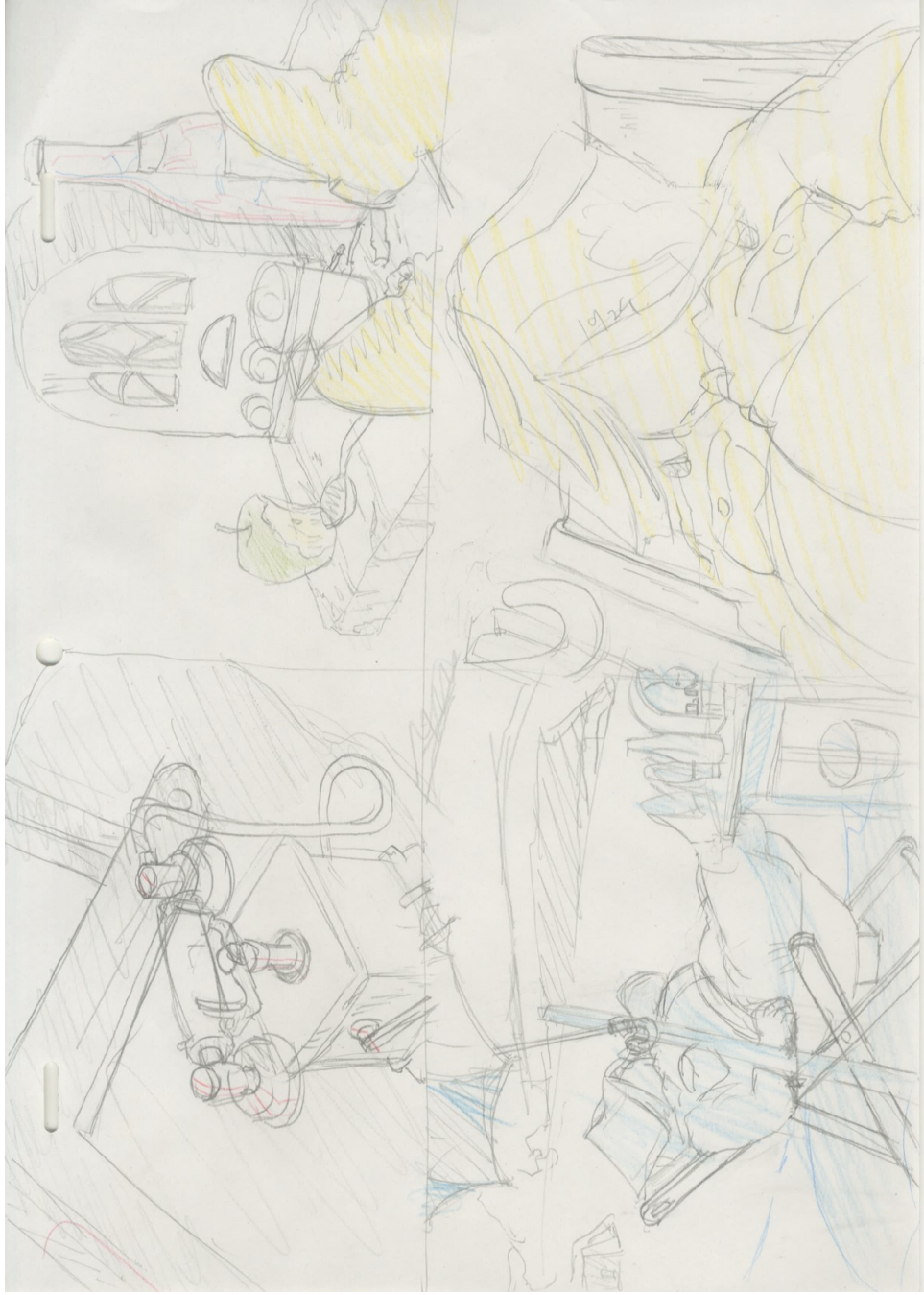



8a

13

7.4.12

2.7.12

6h

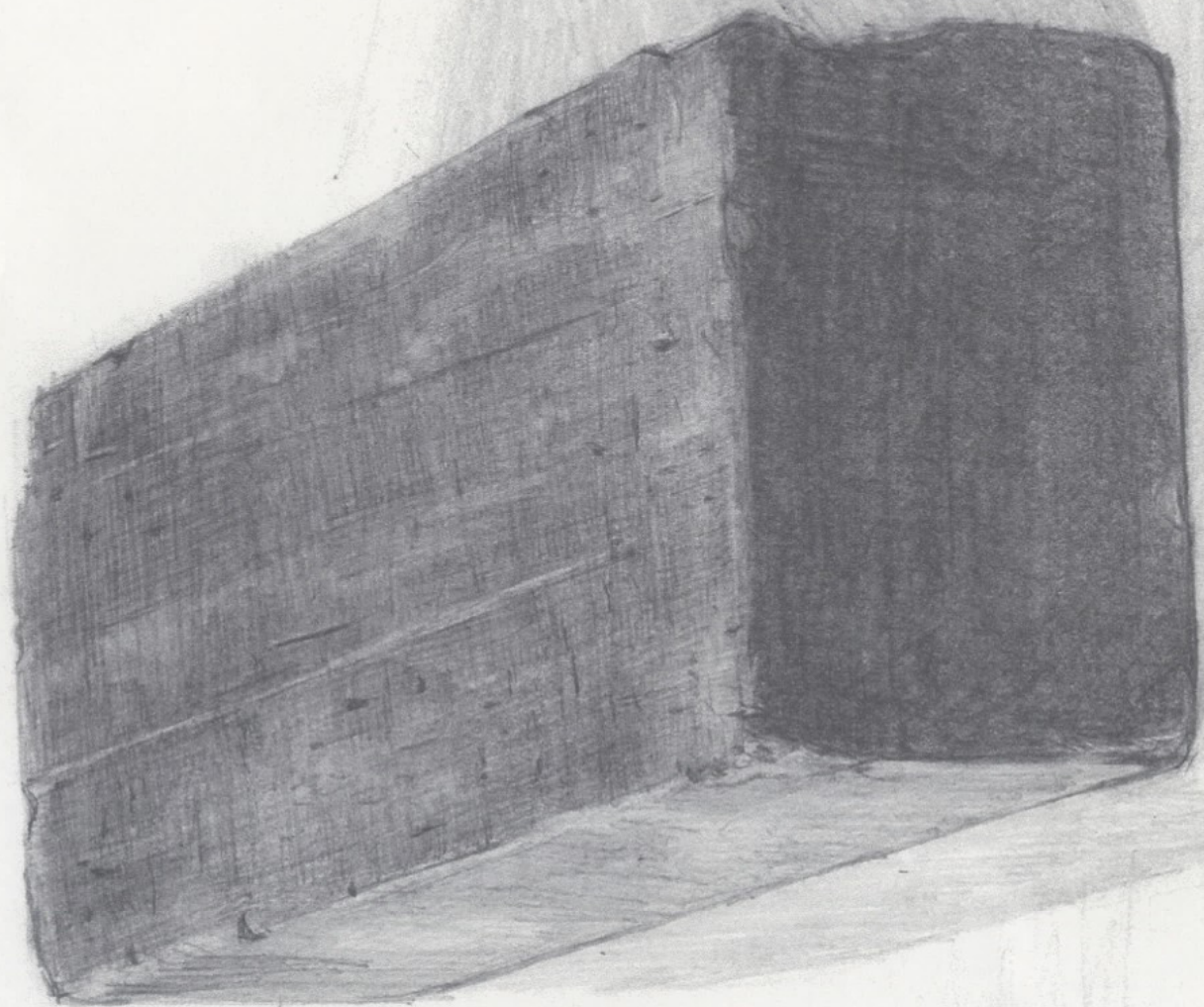

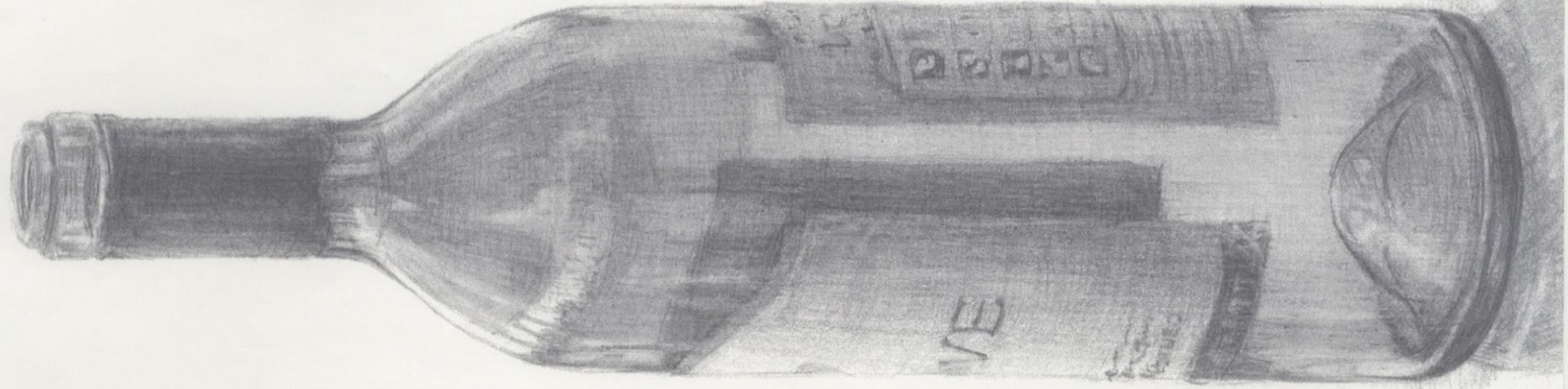

bh

藤本. 2